

Panasonic

2.4GHz Digital Cordless Answering System

Model No. **KX-TG2247S**

Pulse-or-tone dialing capability

Operating Instructions



Caller ID Compatible

PLEASE READ BEFORE USE AND SAVE.

Charge the battery for about 15 hours before initial use.

Panasonic World Wide Web address: <http://www.panasonic.com>
for customers in the USA or Puerto Rico

Preparation

Cordless Telephone

Answering System

Useful Information

Before Initial Use

Please read **IMPORTANT SAFETY INSTRUCTIONS** on page 84 before use. Read and understand all instructions.

Thank you for purchasing your new Panasonic cordless telephone.

Caller ID and Call Waiting Service, where available, are telephone company services. After subscribing to Caller ID, this phone will display a caller's name and phone number. Call Waiting Caller ID, which displays a second caller's name and phone number while the user is on another call, requires a subscription to both Caller ID and Call Waiting.

Attach your purchase receipt here.

For your future reference

Serial No. _____
(found on the bottom of the unit)

Date of purchase _____

Name and address of dealer _____

Trademarks:

•openLCR, openLCR.com, and the openLCR logo are the trademarks of openLCR.com, Inc.

Accessories (included) For extra orders, call 1-800-332-5368.

- AC Adaptor (p. 13)
Order No. PQLV1Z

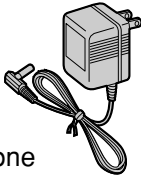

- Telephone Line Cord
(p. 13)
Order No.
PQJA10075Z

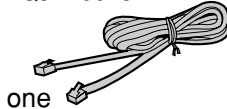

- Battery (p. 14, 73)
Order No.
PQPP511SVC
(P-P511)

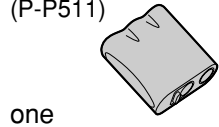

- Handset Cover
(p. 14, 73)
Order No.
PQKK10127Z1



- Wall Mounting
Adaptor (p. 70)
Order No.
PQKL10035Z3

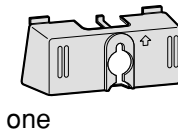

- Belt Clip (p. 72)
Order No.
PQKE10341Z1

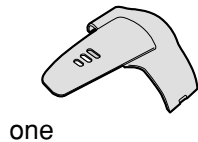

For Best Performance

Battery Charge

A rechargeable Ni-Cd battery powers the handset. Charge the battery for about **15 hours** before initial use (p. 14).

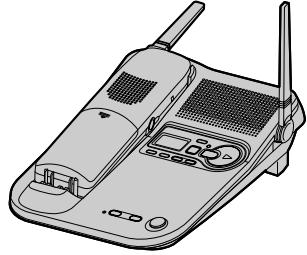

Base Unit Location/Noise

Calls are transmitted between the base unit and the handset using wireless radio waves. **For maximum distance and noise-free operation**, the recommended base unit location is:

Away from electrical appliances such as a TV, personal computer or another cordless phone.

In a HIGH and CENTRAL location with no obstructions such as walls.

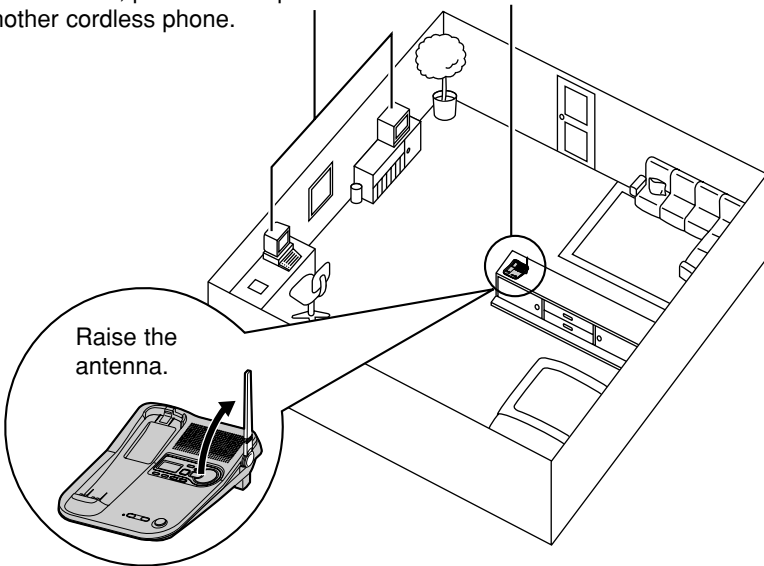

Note:

While using the handset:

- If you are near a microwave oven which is being used, noise may be heard from the receiver or the speaker. Move away from the microwave oven and closer to the base unit.
- If more than one cordless phone is being used and your handset is near another cordless phone's base unit, noise may be heard. Move away from the other cordless phone's base unit and closer to your base unit.

Contents

Preparation

Location of Controls	6
Displays	9
Settings	13
Connections	13
Installing the Battery in the Handset	14
Battery Charge	14
Dialing Mode	16
Line Mode	17
Programmable Functions	18
Auto Talk Feature	19
Ringer Volume	20
Ringer Pattern	21
LCD Contrast	22
Preparing the Answering System	23
Greeting Message	23
Programming Summary for Answering System	25
Day and Time	26
Caller's Recording Time	28
Number of Rings	29

Cordless Telephone

Making Calls	30
Answering Calls	34
Caller ID Service	35
Using the Caller List	36
Viewing the Caller List	36
Calling Back from the Caller List	38
Editing the Caller's Phone Number	39
The Caller ID Number Auto Edit Feature	40
Storing Caller List Information in the Directory	41
Erasing Caller List Information	42
Directory	43
Storing Names and Numbers	43
Entering Names and Symbols	45
Finding Stored Items	47
Dialing	48
Editing	49
Erasing	50
Intercom	51
Special Features	53
Automatic Security Code Setting	53
Temporary Tone Dialing (For Rotary or Pulse Service Users)	53

Muting Your Conversation	53
For Call Waiting Service Users	54
How to Use the PAUSE Button (For Analog PBX Line/Long Distance Service Users)	54
FLASH Button	55

Answering System

Automatic Answering Operation	56
Setting the Unit to Answer Calls	56
Listening to Messages	57
Slow Talk Message Playback	57
From the Handset	59
Erasing Messages	60
Recording a Memo Message	61
Recording Your Telephone Conversation	61
Remote Operation from a Touch Tone Phone	62
Remote Code	63
Voice Menu	64
Direct Remote Operation	66
Remote Operation with the Handset	68

Useful Information

Wall Mounting	70
Belt Clip	72
Optional Headset	72
Battery Replacement	73
Adding Another Phone	74
Troubleshooting	75
openLCR Service for Caller IQ Feature	80
Setting Caller IQ to OFF and ON	81
Downloading the Telephone Directory Data	82
Information Download	83
Important Safety Instructions	84
FCC and Other Information	86
Index	89

Location of Controls

Base unit

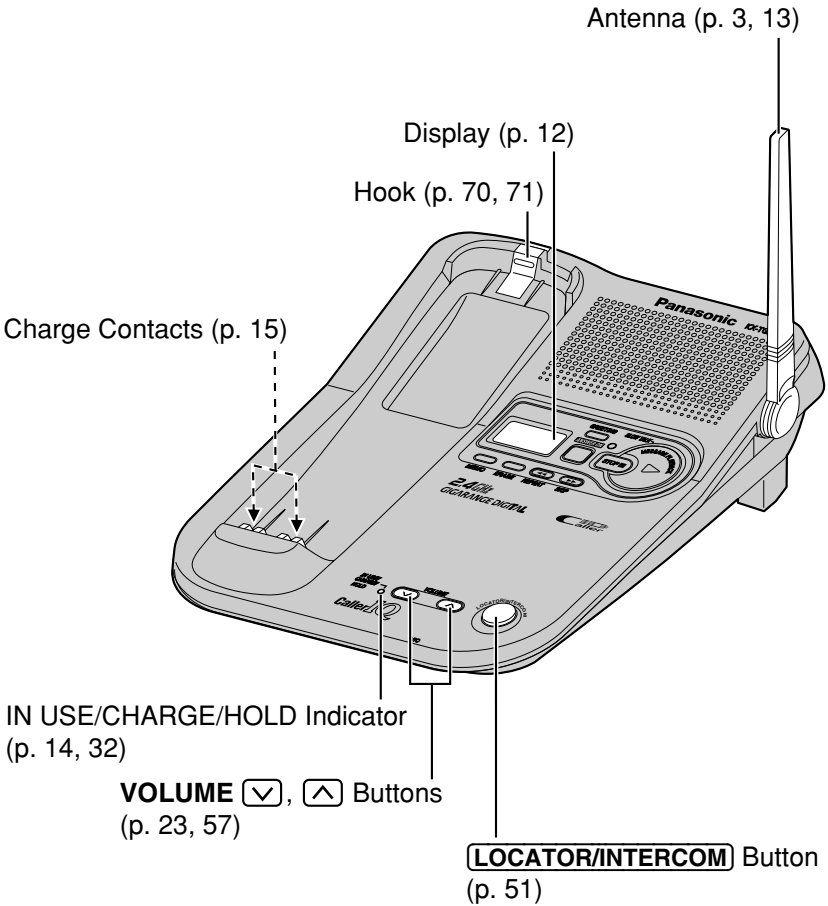

MESSAGE PLAYBACK/SLOW TALK Button (p. 57)

GREETING Button (p. 23)

ANSWER ON Button and Indicator
(p. 56, 60)

ERASE Button (p. 24, 60)

MEMO Button (p. 61)

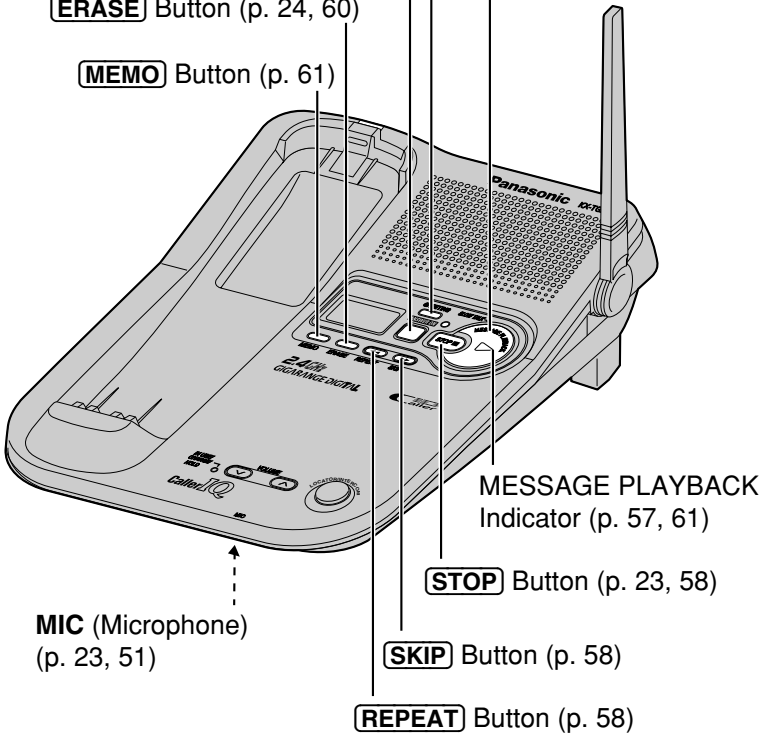

MESSAGE PLAYBACK
Indicator (p. 57, 61)

STOP Button (p. 23, 58)

SKIP Button (p. 58)

REPEAT Button (p. 58)

MIC (Microphone)
(p. 23, 51)

➔ Location of Controls

Handset

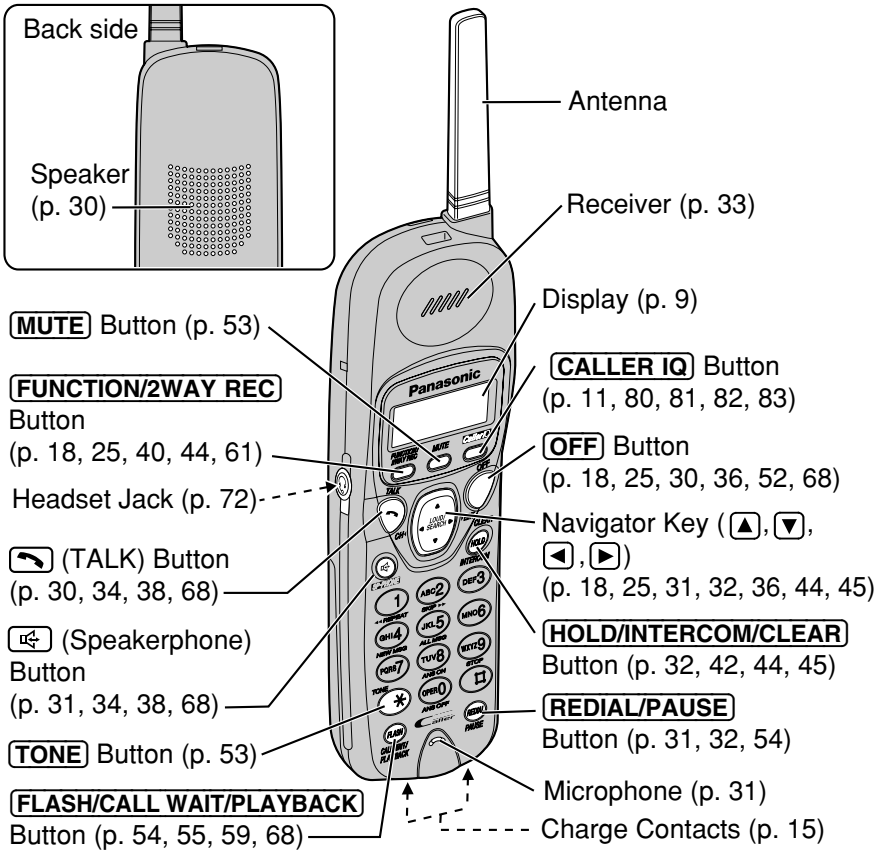

How to use the Navigator key

This key has four active areas that are indicated by arrows.

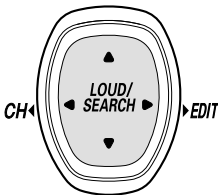

- Pressing the up or down arrow allows you to enter the Caller List and scroll through the function menu, the Caller List and the directory list. It is also used to adjust the handset ringer and receiver/speaker volumes.
- Pressing the right or left arrow allows you to enter the directory list and move the cursor when entering items. The right arrow is used to select or confirm your menu choices and to edit a phone number of the Caller List into one of 3 patterns.

The left arrow is used to select a clearer channel.

Throughout this Operating Instructions, the navigator key is indicated by the arrows ▼, ▲, ◀ or ▶.

Displays



Both the handset and the base unit show you instructions and information on the displays. These display prompts are shown below.

Handset display

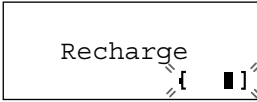

The battery needs to be charged. Place the handset on the base unit to charge the battery (p. 15).

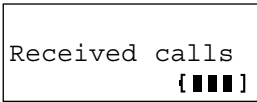

(Handset on the base unit)

The display shows that you have received new calls (p. 36). To check the new calls, lift the handset and press or .

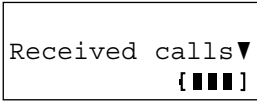

(Handset off the base unit)

The display shows that you have received new calls (p. 36). To check the new calls, press or .

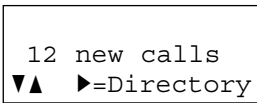

This display shows the number of new calls when or is pressed while the handset is off the base unit.

To search from the most recent call, press . To search from the oldest call, press (p. 36). To go to the directory list, press (Directory key).

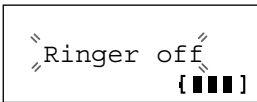

When the handset ringer volume is set to OFF (p. 20), "Ringer off" will flash for about 45 seconds after completing operations such as talk, viewing the Caller List or programming.



When a call is received, the display shows the caller's name and number after the first ring.

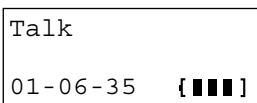

During a conversation, the display shows the length of the call (ex. 1 hour, 6 minutes and 35 seconds). The battery strength is also displayed (p. 15).

➔ Displays

No link to base
Place on cradle
and try again.

The handset has lost communication with the base unit. Place the handset on the base unit and try again.

SMITH, JACK
1-222-333-4444
11:20A JAN10 X3

This is a name from the Caller List. The display shows:

- the caller's name,
- the caller's number,
- the time and date of the last call (ex. Jan. 10, 11:20 AM), and
- the number of times called (ex. 3 times).

Ann
123-456-7890

This is a name from the directory. The stored name and phone number are displayed.

BROWN, NANCY
1-555-666-7777
----Waiting----

A second call is received during a conversation (p. 54).

Please lift up
and try again.

⏏, ⏪, ⏩ or ⏴ was pressed while the handset was on the base unit. Lift the handset and press the button again.

Not available

While the base unit was in use, ⏏ or ⏪ was pressed to search the Caller List/directory list, ⏴ was pressed to select an option or **HOLD/INTERCOM/CLEAR** was pressed.



Directory full

When trying to store an item or Caller List information in the directory, the directory memory is full (p. 41, 44).

Save error

While programming procedure, the handset has lost communication with the base unit. Move closer to the base unit and try again.



Remote operation
[■■■■]

The handset is operating the answering system remotely (p. 68).

[Caller IQ on]
[■■■■]

Caller IQ service is set to ON.

Set Caller IQ to on.

CALLER IQ was pressed after  or , while Caller IQ function was OFF.

Download incomplete.
Directory full.

When trying to download an item in the directory, the directory memory is full (p. 82).

Download incomplete.
Try again.

During downloading, the unit has lost communication with openLCR.

➔ Displays

Base unit display



The clock needs adjusting (p. 26).

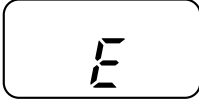

Your greeting or memo message was not recorded correctly. Record it again (p. 23, 61).



The unit is in the answering system programming mode.

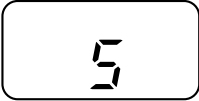

The speaker volume level is set to "5".

You can select:

—9 levels (0–8) are available while using the answering system (p. 23, 57).

—8 levels (1–8) are available while using the intercom (p. 52).

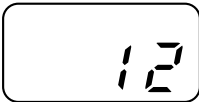

12 messages have been recorded.



Memory is full. Erase some, or all, of the messages (p. 60).

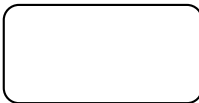

The recording time is set to "Greeting only" (p. 28). (The display is blank.)



The unit is downloading from openLCR.

Settings



Connections

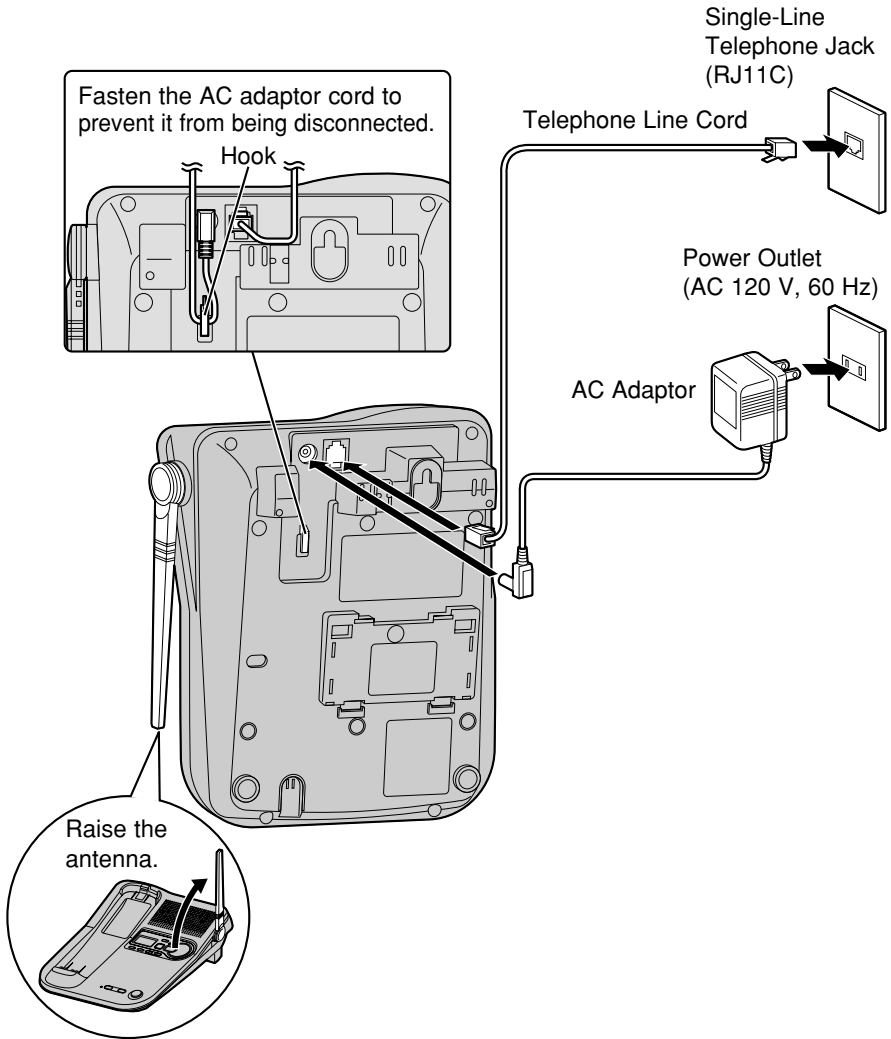

- USE ONLY WITH Panasonic AC ADAPTOR PQLV1 (Order No. PQLV1Z).
- The AC adaptor must remain connected at all times. (It is normal for the adaptor to feel warm during use.)
- To connect a standard telephone on the same line, see page 74.
- If your unit is connected to a PBX which does not support Caller ID services, you cannot access those services.

Installing the Battery in the Handset

Insert the battery into the handset as shown (①), matching the correct polarity. Press the battery down until it places into the compartment (②). When finished, close the cover.

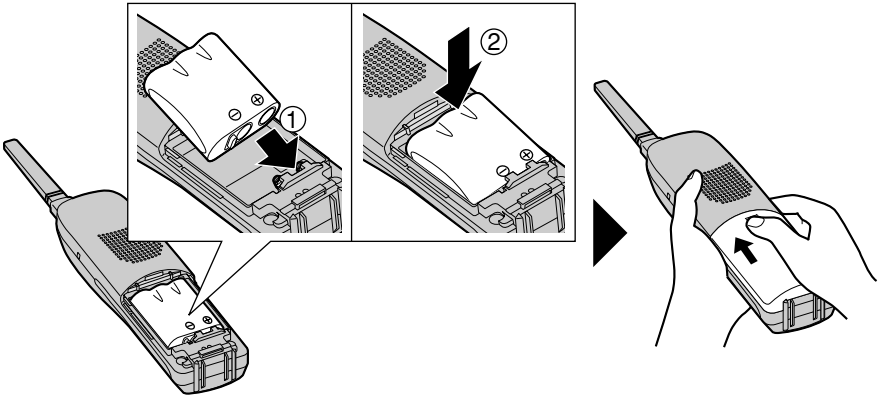

Battery Charge

Place the handset on the base unit and charge for about **15 hours** before initial use.

- The IN USE/CHARGE/HOLD indicator lights and a beep sounds.

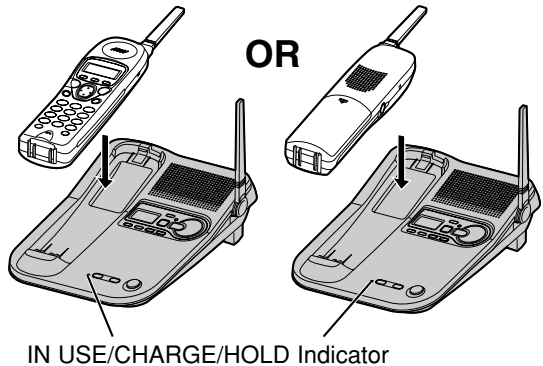



Battery strength

You can check the battery strength on the handset display. The battery strength is as shown in the chart below.

Display prompt	Battery strength
{ ■■■■ }	Fully charged
{ ■■■ }	Medium
{ ■■ }	Low
⚡{ ■■ }⚡ (flashing)	Needs to be recharged.

Recharge

Recharge the battery when:

- “Recharge” is displayed on the handset,
- “{ ■■ }” flashes on the display, or
- the handset beeps intermittently while it is in use.

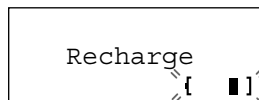

- If you DO NOT recharge the handset battery for more than 15 minutes, the display will keep indicating “Recharge” and/or “{ ■■ }” will continue to flash.

Battery information

After your Panasonic battery is fully charged (p. 14):

Operation	Operating time
While in use (TALK)	Up to 5 hours
While not in use (Standby)	Up to 11 days

- The battery operating time may be shortened depending on usage conditions, such as viewing the Caller ID Caller List or directory list, and ambient temperature.
- Clean the handset and the base unit charge contacts with a soft, dry cloth once a month. Clean more often if the unit is subject to grease, dust or high humidity.** Otherwise the battery may not charge properly.
- If the battery is fully charged, you do not have to place the handset on the base unit until “Recharge” is displayed and/or “{ ■■ }” flashes. This will maximize the battery life.
- The battery cannot be overcharged.

➡ Settings

Dialing Mode

If you have touch tone service, set to “Tone”. If rotary or pulse service is used, set to “Pulse”. Your phone comes from the factory set to “Tone”.

Make sure the unit is not being used and the handset is lifted off the base unit.

1 Press **FUNCTION/2WAY REC**.

```
-----
▶Save directory
Ringer volume
```

2 Scroll to “Program” by pressing **▼** or **▲**.

```
Ringer pattern
▶Program
-----
```

3 Press **▶**.

```
-----
▶TAD program
Set flash time
```

4 Scroll to “Set dial mode” by pressing **▼** or **▲**.

```
Set line mode
▶Set dial mode
Talk switching
```

5 Press **▶**.

```
Dial mode
: Tone
▼▲ ▶=Save
```

6 Select “Pulse” or “Tone” by pressing **▼** or **▲**.

```
Dial mode
: Pulse
▼▲ ▶=Save
```

7 Press **▶** (Save key).

- A beep sounds.
- To exit the programming mode, press **OFF**.

```
Dial mode
: Pulse
```

•You can exit the programming mode any time by pressing **OFF**.

Line Mode

If the line is connected to a low voltage system such as a PBX, set to "B". Your phone comes from the factory set to "A".

Make sure the unit is not being used and the handset is lifted off the base unit.

- 1 Press **FUNCTION/2WAY REC**.

```
-----
▶Save directory
Ringer volume
```
- 2 Scroll to "Program" by pressing **▼** or **▲**.

```
Ringer pattern
▶Program
-----
```
- 3 Press **▶**.

```
-----
▶TAD program
Set flash time
```
- 4 Scroll to "Set line mode" by pressing **▼** or **▲**.

```
Set flash time
▶Set line mode
Set dial mode
```
- 5 Press **▶**.

```
Line mode
: A
▼▲ ▶=Save
```
- 6 Select "B" or "A" by pressing **▼** or **▲**.

```
Line mode
: B
▼▲ ▶=Save
```
- 7 Press **▶** (Save key).
 - A beep sounds.
 - To exit the programming mode, press **OFF**.

```
Line mode
: B
```

•You can exit the programming mode any time by pressing **OFF**.

Programmable Functions

You can program the following function items **using the handset near the base unit**. The display shows the programming instructions. See the corresponding pages for function details.

Make sure the unit is not being used and the handset is lifted off the base unit.

Press **FUNCTION/2WAY REC**.

<Function menu>*

▶ Save directory..... To store an item in the directory (p. 44).
Ringer volume To select the ringer volume (p. 20).
Ringer pattern..... To select the ringer pattern (p. 21).
Program

Press **▶**.

<Function menu>*

▶ TAD program..... To program answering system functions (p. 25).
Set flash time..... To select the flash time (p. 55).
Set line mode..... To select the line mode (p. 17).
Set dial mode..... To select the dialing mode (p. 16).
Talk switching..... To set the Auto Talk feature (p. 19).
CallerID edit..... To set the Caller ID Number Auto Edit feature (p. 40).
LCD contrast To select the LCD contrast (p. 22).



During programming:

*To select a desired function item, scroll through the items by pressing **▼** or **▲**. Then press **▶** to go to the next step.

- “-----” indicates the beginning or end of the function menu.
- You can exit the programming mode any time by pressing **OFF**.
- If you do not press any buttons for 60 seconds, the unit will exit the programming mode.
- If the handset has lost communication with the base unit, 3 beeps sound and “No link to base Place on cradle and try again.” is displayed.





Auto Talk Feature

The Auto Talk feature allows you to answer a call by lifting the handset off the base unit without pressing  or . If you want to use this feature, turn the feature ON by programming. Your phone comes from the factory set to OFF.



Make sure the unit is not being used and the handset is lifted off the base unit.

1 Press **FUNCTION/2WAY REC**.

2 Scroll to "Program" by pressing  or .

```
Ringer pattern
▶Program
-----
```



3 Press .

4 Scroll to "Talk switching" by pressing  or .

```
Set dial mode
▶Talk switching
CallerID edit
```

5 Press .

```
Auto talk
:Off
▼▲ ▶=Save
```

6 Select "On" or "Off" by pressing  or .

```
Auto talk
:On
▼▲ ▶=Save
```

7 Press  (Save key).

- A beep sounds.
- To exit the programming mode, press **OFF**.

```
Auto talk
:On
```

- You can exit the programming mode any time by pressing **OFF**.
- In order to view Caller ID information after you lift up the handset to answer a call, leave the Auto Talk feature OFF.

➔ Programmable Functions

Ringer Volume

You can program the handset ringer volume to HIGH, LOW or OFF. If set to OFF, the handset will not ring. Your phone comes from the factory set to HIGH.

Make sure the unit is not being used and the handset is lifted off the base unit.

1 Press **FUNCTION/2WAY REC**.

2 Scroll to "Ringer volume" by pressing **▼** or **▲**.

```
Save directory
▶Ringer volume
Ringer pattern
```

3 Press **▶**.

4 Select the desired volume by pressing **▼** or **▲**.

- Each time you press **▼** or **▲**, the volume will change and ring.
- If you set to OFF, the unit will not ring.

5 Press **▶** (Save key).

- A beep sounds.

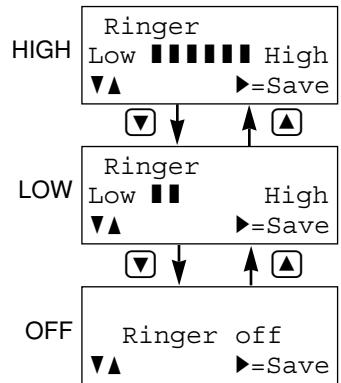

- You can exit the programming mode any time by pressing **OFF**.
- When you replace the battery, the selected ringer volume setting will return to the factory set (HIGH). Reprogram if necessary.



Ringer Pattern

You can select the handset ringer pattern out of 6 patterns. When an incoming call is being received, the unit rings in the selected pattern. Your phone comes from the factory set to 1.

Make sure the unit is not being used and the handset is lifted off the base unit.

1 Press **FUNCTION/2WAY REC**.

2 Scroll to "Ringer pattern" by pressing **▼** or **▲**.

```
Ringer volume
▶Ringer pattern
Program
```

3 Press **▶**.
•The current setting is displayed.

```
Ringer pattern
:1
▼▲ ▶=Save
```

4 Select the desired ringer pattern by pressing **▼** or **▲**.
•Each time you press **▼** or **▲**, the ringer pattern will change and ring.
•You can also select the ringer pattern by pressing dialing buttons **1** to **6**.
•If you set the ringer volume to OFF, the handset will not ring (p. 20).

```
Ringer pattern
:3
▼▲ ▶=Save
```

5 Press **▶** (Save key).
•A beep sounds.
•To exit the programming mode, press **OFF**.

```
Ringer pattern
:3
```

•You can exit the programming mode any time by pressing **OFF**.

➔ Programmable Functions

LCD Contrast

You can program the handset LCD contrast (5 levels). To make the handset display clearer, set to high level. Your phone comes from the factory set to level 3.

Make sure the unit is not being used and the handset is lifted off the base unit.

1 Press **FUNCTION/2WAY REC**.

2 Scroll to "Program" by pressing **▼** or **▲**.

```
Ringer pattern
▶Program
-----
```

3 Press **▶**.

```
-----
▶TAD program
Set flash time
```

4 Scroll to "LCD contrast" by pressing **▼** or **▲**.

```
CallerID edit
▶LCD contrast
-----
```

5 Press **▶**.

```
LCD contrast
Low ■■■ High
▼▲ ▶=Save
```

6 Select the desired contrast by pressing **▼** or **▲**.

- Each time you press **▼** or **▲**, the LCD contrast will change.

7 Press **▶** (Save key).

- A beep sounds.
- To exit the programming mode, press **OFF**.

```
LCD contrast
Low ■ High
```

- You can exit the programming mode any time by pressing **OFF**.

Preparing the Answering System

Greeting Message

You can record a personal greeting message of **up to 2 minutes**. If a greeting message is not recorded, one of two pre-recorded greetings will be played when a call is received (p. 24).

All messages (greeting, incoming, memo, etc.) are stored in digital memory (p. 24). The **total recording time is about 15 minutes**. We recommend you record a **brief greeting message** (see sample below) in order to leave more time for recording new messages.

To record a greeting message

- 1 Press and hold **[GREETING]** until "Record greeting after the beep" is heard.
 - A long beep sounds.
- 2 Talk clearly, about 8 inches (20 cm) away from the **MIC** (microphone).
 - The base unit display shows the elapsed recording time.
 - If you record for over 2 minutes, the unit will automatically stop recording.
- 3 When finished, press **[GREETING]**.
 - The unit will automatically play back the recorded greeting.
 - You can also finish recording by pressing **[STOP]**.
 - To change the message, start again from step 1.

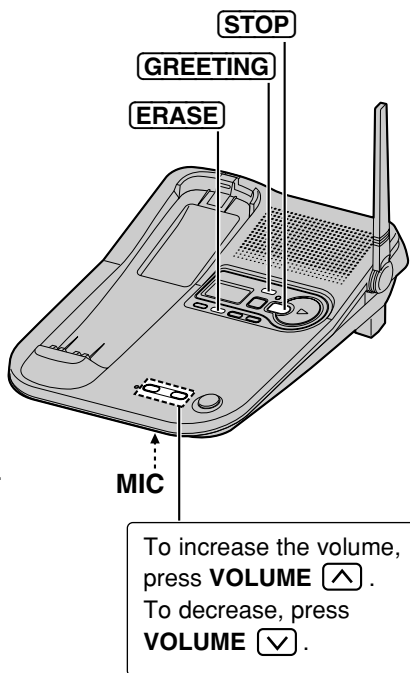

Greeting message sample

"Hello, this is (your name and/or number). Sorry I cannot take your call. Please leave a message after the beep. Thank you."

➡ Preparing the Answering System

To check the recorded greeting message

Press **[GREETING]**.

To erase the recorded greeting message

Press **[GREETING]**, and then press **[ERASE]** while the message is being played.

- The unit will answer a call with a pre-recorded greeting.

Pre-recorded greeting message

If you do not record a greeting message (p. 23), one of two messages will be played when a call is received, depending on the caller's recording time (p. 28).

To check the pre-recorded greeting, press **[GREETING].**

- A pre-recorded greeting will be played as follows:

- When the recording time is set to "1 minute", "2 minutes" or "3 minutes":
"Hello, we are not available now. Please leave your name and phone number after the beep. We will return your call."
- When the recording time is set to "Greeting only":
"Hello, we are not available now. Please call again. Thank you for your call."

Flash Memory Message Backup

Messages are stored on a "flash memory" IC chip and will not be affected by power failures. All messages are saved until you erase them.



Programming Summary for Answering System

You can program the following functions **using the handset near the base unit**. The display shows the programming instructions. See the corresponding pages for function details.

Make sure the unit is not being used and the handset is lifted off the base unit.

Press **FUNCTION/2WAY REC**.



Scroll to "Program" by pressing **▼** or **▲**, and press **▶**.



Press **▶** at "TAD program".



Select the desired function by pressing **▼** or **▲**, and press **▶**.

▶Day and time.....To adjust the day and time (p. 26).

Remote code.....To set the remote code (p. 63).

Number of ring.....To select the number of rings (p. 29).

Recording time.....To select the caller's recording time (p. 28).



When finished setting, press **▶** (Save key).

- A beep sounds from the base unit.
- To exit the programming mode, press **OFF**.

- “-----” indicates the beginning or end of the function menu.
- You can exit the programming mode any time by pressing **OFF**.
- If you do not press any buttons for 60 seconds, the unit will exit the programming mode.
- If the handset has lost communication with the base unit, 3 beeps sound and “No link to base Place on cradle and try again.” is displayed.

➔ Preparing the Answering System

Day and Time

Voice Day/Time Stamp: During playback, a synthesized voice will announce the day and time that each message was recorded.

Make sure the unit is not being used and the handset is lifted off the base unit.

- 1 Press **[FUNCTION/2WAY REC]**.

▶Save directory
Ringer volume
- 2 Scroll to “Program” by pressing **[▼]** or **[▲]**.

Ringer pattern
▶Program

- 3 Press **[▶]**.

▶TAD program
Set flash time
- 4 Press **[▶]** at “TAD program”.

▶Day and time
Remote code
- 5 Press **[▶]** at “Day and time”.
 - “Set time” is announced.
 - If previously adjusted, the day/time will be heard.

SUN 12:00 AM
#=Day 0-9=Time
*=AM/PM ▶=Save
- 6 Enter the current time (hour and minute) using a 4-digit number.
(Ex. To set 9:30, enter “0930”).

SUN 09:30 AM
#=Day 0-9=Time
*=AM/PM ▶=Save
- 7 Press **[*]** to select “AM” or “PM”.
Press **[#]** repeatedly to set the day.

MON 09:30 AM
#=Day 0-9=Time
*=AM/PM ▶=Save
- 8 Press **[▶]** (Save key).
 - The base unit announces the day/time. The clock starts working.
 - If 6 beeps sound from the base unit, the setting is not correct. Start again from step 5.
 - To exit the programming mode, press **[OFF]**.

MON 09:30 AM

•You can exit the programming mode any time by pressing **[OFF]**.



- In step 6, you cannot enter numbers greater than 12. **Do not use military time.** (To set 13:00 hours, enter “0100”, and select “PM” by pressing )

If a power failure occurs, the time may be shifted. When “” flashes on the base unit display, reprogram the current day/time.

To check the day/time

Repeat steps 1 to 5 on page 26.

- The base unit announces the current day/time displayed on the handset. When finished, press .

For Caller ID service users (p. 35)

- The Caller ID information will reset the clock after the first ring if the adjusted time is incorrect. However, the day will not be reset by the Caller ID information. Adjust the correct day by following the steps on page 26.
- If the time has not previously been set, the Caller ID information will not adjust the clock.
- The Caller ID information will automatically adjust the clock for daylight saving time.

➡ Preparing the Answering System

Caller's Recording Time

You can select "1 minute", "2 minutes", "3 minutes" or "Greeting only" for the caller's recording time. Your phone comes from the factory set to "3 minutes".

Make sure the unit is not being used and the handset is lifted off the base unit.

1 Press **FUNCTION/2WAY REC**.

2 Scroll to "Program" by pressing **▼** or **▲**.

```
Ringer pattern
▶Program
-----
```

3 Press **▶**.

```
-----
▶TAD program
Set flash time
```

4 Press **▶** at "TAD program".

```
-----
▶Day and time
Remote code
```

5 Scroll to "Recording time" by pressing **▼** or **▲**.

```
Number of ring
▶Recording time
-----
```

6 Press **▶**.
•The current setting is displayed.

```
Recording time
:3min
▼▲ ▶=Save
```

7 Select the recording time by pressing **▼** or **▲**.

- You can also select the recording time by pressing dialing buttons **1** (1 minute), **2** (2 minutes), **3** (3 minutes) or **0** (Greeting only).

8 Press **▶** (Save key).

- A beep sounds from the base unit.
- To exit the programming mode, press **OFF**.
- If "Greeting only" is selected, the base unit display will become blank.

```
Recording time
:Greeting only
```

•You can exit the programming mode any time by pressing **OFF**.

If you select "Greeting only", the unit will answer a call with the greeting message, and then hang up. The unit will not record any incoming messages.

Number of Rings

You can select the number of times the unit rings before the answering system answers a call, from “2” to “7” or “Toll saver”*.

Your phone comes from the factory set to “4”.

Make sure the unit is not being used and the handset is lifted off the base unit.

- 1 Press **FUNCTION/2WAY REC**.
 - 2 Scroll to “Program” by pressing **▼** or **▲**.

Ringer pattern
 ▶Program

 - 3 Press **▶**.

 ▶TAD program
 Set flash time
 - 4 Press **▶** at “TAD program”.

 ▶Day and time
 Remote code
 - 5 Scroll to “Number of ring” by pressing **▼** or **▲**.

Remote code
 ▶Number of ring
 Recording time
 - 6 Press **▶**.
 - The current setting is displayed.

Number of rings
 :4
▼▲ ▶=Save
 - 7 Select the number of rings by pressing **▼** or **▲**.
 - You can also select the number of rings by pressing dialing buttons **2** to **7** or **0** (Toll saver*).

Number of rings
 :Toll saver
▼▲ ▶=Save
 - 8 Press **▶** (Save key).
 - A beep sounds from the base unit.
 - To exit the programming mode, press **OFF**.

Number of rings
 :Toll saver
- You can exit the programming mode any time by pressing **OFF**.

*Toll saver

If the unit answers on the 2nd ring, there is at least one new message.
 If the unit answers on the 4th ring, there are no new messages.

Hang up when you hear the 3rd ring. This will save you the toll charge for the call.

Making Calls

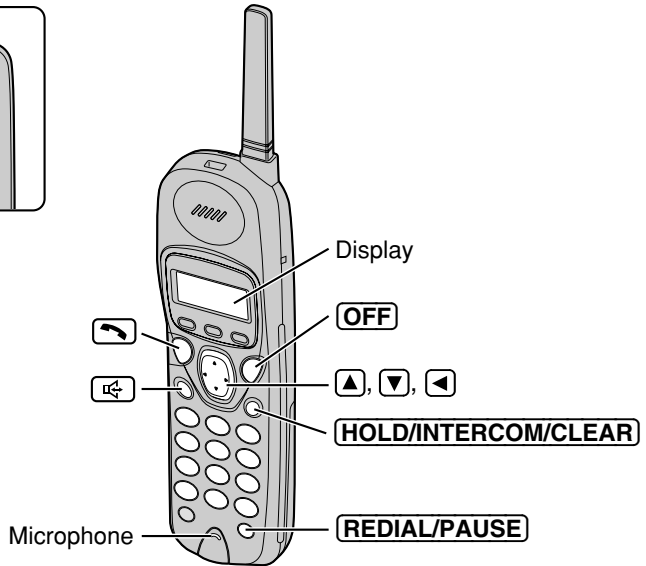
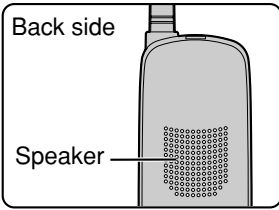

1 Press .

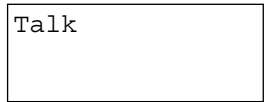

2 Dial a phone number.

- The dialed number is displayed.
- After a few seconds, the display will show the length of the call and the battery strength.

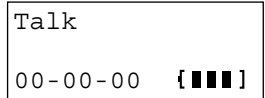

3 To hang up, press **OFF** or place the handset on the base unit.

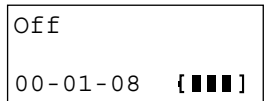

•If the handset has lost communication with the base unit, 3 beeps sound and “No link to base Place on cradle and try again.” is displayed.



To have a hands-free phone conversation (Using Digital Duplex Speakerphone)

1 Press .

SP-phone

2 Dial a phone number.

- The dialed number is displayed.
- After a few seconds, the display will show the length of the call and the battery strength.

SP-phone
1112222

3 When the other party answers, talk into the microphone.

SP-phone
00-00-00 [||||]





4 To hang up, press **OFF** or place the handset on the base unit.

Off
00-01-08 [||||]

- If the handset has lost communication with the base unit, 3 beeps sound and “No link to base Place on cradle and try again.” is displayed.

Hands-free Digital Duplex Speakerphone



For best performance, please note the following:

- Talk alternately with the caller in a quiet room.
- If the other party has difficulty hearing you, press  to decrease the speaker volume.
- If the other party's voice from the speaker cuts in/out during a conversation, press  to decrease the speaker volume.
- While talking using , you can switch to the hands-free phone conversation by pressing . To switch back to the receiver, press .

If noise interferes with the conversation

Press  to select a clearer channel in the talk, speakerphone, intercom or remote operation mode, or move closer to the base unit.

To redial the last number dialed on the handset

Press  or  and press **REDIAL/PAUSE**.

➡ Making Calls

To dial after confirming the entered number

- 1 Dial a phone number.
 - If you misdial, press **[HOLD/INTERCOM/CLEAR]**. One digit is erased. Dial the correct phone number.

3334444

- 2 Press **[📞]**.
OR
To have a hands-free phone conversation, press **[📞]**, and when the other party answers, talk into the microphone.
 - After a few seconds, the display will show the length of the call and the battery strength.

Ex. **[📞]** was pressed.

Talk
3334444

Talk
00-00-00 [■■■■]

- 3 To hang up, press **[OFF]** or place the handset on the base unit.

To redial using the redial list (Memory Redial)

The last 5 phone numbers dialed with the handset are stored in the redial list.

1. Press **[REDIAL/PAUSE]**.
 - The last number dialed is displayed.
2. Scroll to the desired number by pressing **[▼]** or **[▲]**.
 - You can also scroll through the list by pressing **[REDIAL/PAUSE]**.
 - To exit the list, press **[OFF]**.
3. Press **[📞]** or **[📞]**.

333-4444
▼▲Redial list

- To erase an item, repeat steps 1 and 2, and press **[HOLD/INTERCOM/CLEAR]**.
- If “No items stored” is displayed, the list is empty.

To put a call on hold

Press **[HOLD/INTERCOM/CLEAR]**.

- “Hold” is displayed.
- The IN USE/CHARGE/HOLD indicator on the base unit flashes.
- If you put a call on hold for more than 6 minutes, an alarm tone will sound. The call will be disconnected after a total of 10 minutes.

Hold
00-00-08 [■■■■]

To release the hold

Lift the handset, or press **[📞]** or **[📞]**.

- If another phone is connected on the same line (p. 74), you can also release the hold by lifting its handset.



To adjust the receiver volume (HIGH, MEDIUM or LOW) or speaker volume (6 levels) while talking

To increase, press .

To decrease, press .



- The display will return to the length of the call.

While using

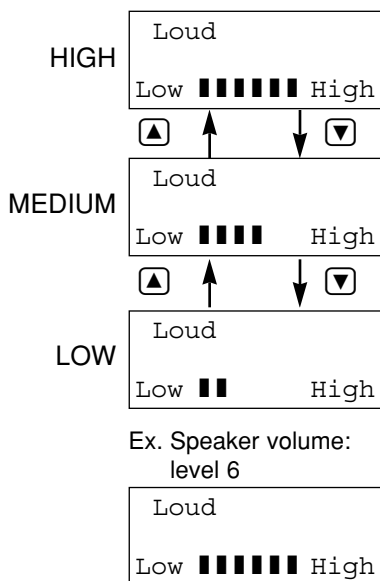
- Each time you press  or , the volume level will change among 3 levels (HIGH, MEDIUM or LOW). Your phone comes from the factory set to level MEDIUM.



While using

- Each time you press  or , the volume level will change among 6 levels. Your phone comes from the factory set to level 3.

- When you replace the battery, the selected receiver/speaker volume setting will return to the factory set. Reprogram if necessary.

Lighted handset keypad

The handset dialing buttons will light when you press a button or lift the handset off the base unit. They flash when a call is received with the handset off the base unit.

The lights will go out a few seconds after pressing a button, lifting the handset, answering a call, hanging up a call, leaving the programming mode or ending the intercom.

Backlit LCD display

The lighted handset display will stay on for a few seconds after pressing a handset button, lifting the handset off the base unit, hanging up a call, leaving the programming mode or ending the intercom.





Answering Calls

When a call is received, the unit rings and “Incoming call” is displayed and the IN USE/CHARGE/HOLD indicator on the base unit flashes quickly. If you subscribe to a Caller ID service, the calling party information will be displayed after the first ring (p. 35).

In order to view the Caller ID information, please wait until the second ring to answer a call.

If the handset is off the base unit;



Press .

- You can also answer a call by pressing any dialing button  to ,  or  (—Any Key Talk).

OR

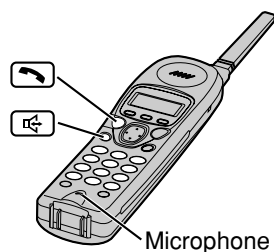

Press , and when the other party answers, talk into the microphone.



- You can select the ringer volume while a call is being received. Press  or  while the handset is just ringing. To set to OFF, press and hold .

Auto Talk

If you set the Auto Talk feature to ON (p. 19), you can answer a call by lifting the handset off the base unit without pressing

 or .

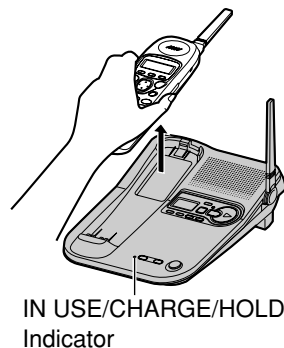

- When the handset ringer volume is set to OFF, the unit will not ring (p. 20).

Caller ID Service

This unit is compatible with a Caller ID service offered by your telephone company. If you subscribe to a Caller ID service, the calling party's information will be shown on the handset after the first ring.

The unit can record information of up to 30 different callers, including the time and date received and the number of times called, in the Caller List. The Caller List information is sorted by the most recent to the oldest call. When the 31st call is received, the first call is deleted.

Using the list, you can automatically call back a caller. You can store the callers' names and numbers from the Caller List into the directory.

If you subscribe to both Caller ID and Call Waiting services, when a second call is received while talking, the new caller's name and phone number will be displayed (p. 54).

How caller information is displayed when a call is received

The handset display shows the caller's name and phone number after the first ring.

After you answer the call, the display will show the length of the call and the battery strength.

ROBINSON, TINA
1-000-222-3333

Talk
00-00-00 [||||]

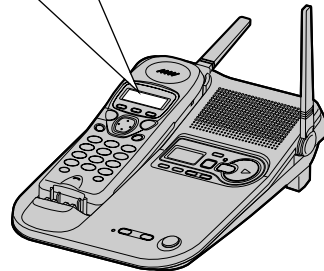

- Caller information cannot be displayed in the following cases:
 - If the caller dialed from an area which does not provide a Caller ID service, the display will show "Out of area".
 - If the caller has requested not to display his/her information, the display will show "Private caller".
- If your unit is connected to a PBX which does not support Caller ID services, you cannot access those services.
- The name display service may not be available in some areas. For further information, please contact your telephone company.

Using the Caller List

If you have received new calls, "Received calls" will be displayed while the unit is not in use.

Handset on the base unit

Received calls
{■■■■}

Handset off the base unit

Received calls▼
{■■■■}

Viewing the Caller List

To check who has called, follow the steps below.

Make sure the unit is not being used and the handset is lifted off the base unit.

- 1 Press ▼ or ▲ to enter the Caller List.
 - The display will show, for example, the following.

2 new calls
▼▲ ▶=Directory

- You can go to the directory list by pressing ▶ (p. 47).

- 2 To search from the most recent call, press ▼.
To search from the oldest call, press ▲.
 - To scroll between callers, press ▼ or ▲.

- 3 To exit the list, press OFF.

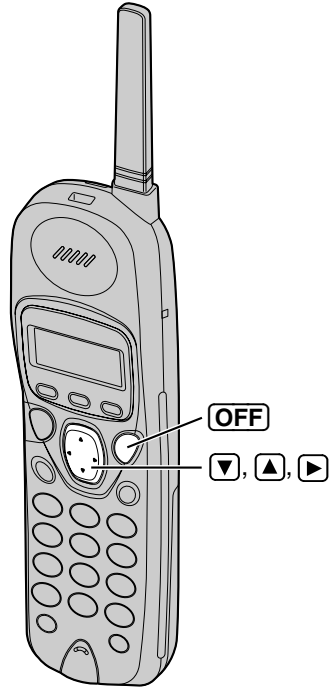

- Once new calls have been checked, "√" will be added.
- If "No items stored" is displayed in step 1, the Caller List is empty.
- If more than one call is received from the same caller, the date and time of the most recent call will be recorded. If the same caller calls again, the call entry with "√" will be deleted.
- If you do not press any buttons for 60 seconds, the unit will exit the Caller List.
- After viewing all of the new call entries, "Received calls" will disappear.



Ex. When you search from the most recent call:

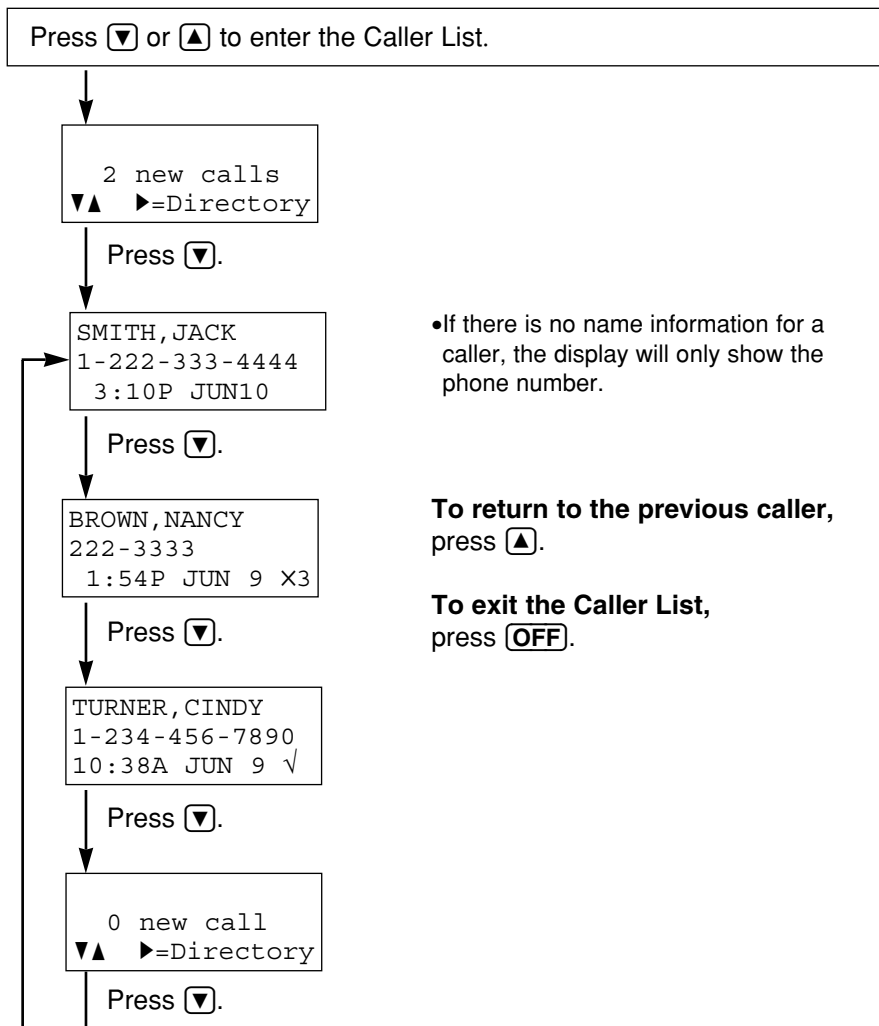

• If there is no name information for a caller, the display will only show the phone number.

To return to the previous caller,
press **▲**.

To exit the Caller List,
press **OFF**.

Display meaning:

- ✓ : You have checked this caller information, answered the call, called back the caller or played back the message.
- X2-X9 : The number of times the same caller called (up to 9).
After checking, "X2" – "X9" will be replaced with "✓".

➔ Using the Caller List

Calling Back from the Caller List

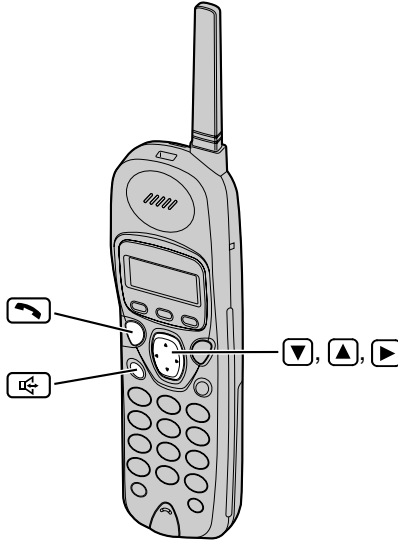

- 1 Press or to enter the Caller List.

3 new calls
▼▲ ▶=Directory

- 2 Scroll to the desired caller by pressing or .

TURNER, CINDY
1-234-456-7890
11:20A JAN12 X3

- 3 Press or .
•The displayed phone number is dialed automatically.

Ex. was pressed.

Talk
12344567890

- In some cases, you may have to edit the number before dialing (p. 39).
(Ex. You may have to delete “1” and the area code.)
- If a phone number is not displayed in the caller information, you cannot call back that caller.



Editing the Caller's Phone Number

You can edit a phone number into one of 3 patterns (see below ①, ②, and ③ on this page) to call back or store it into the directory.

The Caller ID Number Auto Edit Feature (p. 40)

This feature will allow the unit to edit a Caller ID number into one of 3 patterns you desired for you automatically in the Caller List. For detail and activation please see page 40.

Make sure the unit is not being used and the handset is lifted off the base unit.

1 Press or to enter the Caller List.

5 new calls
▼▲ ▶=Directory

2 Scroll to the desired caller by pressing or , and press .

PARKER, FRED
1-234-321-5555
11:20A JAN12 ✓

▶Edit
Save directory
▼▲ ▶=Yes

3 Press (Yes key) at "Edit".

PARKER, FRED
1-234-321-5555
▼=Next ▶=Edit

4 Press (Edit key) to select a pattern.

① 321-5555
▼=Next ▶=Edit

- Each time you press , the number is rearranged into one of 3 patterns.

① (7 digit pattern)

② - (10 digit pattern)

③ 1- - (11 digit pattern)

- The order in which patterns ①-③ are displayed depends on how the telephone number is displayed in step 3.

② 234-321-5555
▼=Next ▶=Edit

③ 1-234-321-5555
▼=Next ▶=Edit

5 After editing the number, you can continue with calling back or storing procedures.

To call back, press or (p. 38).

To store the number in the directory, press (Next key). Follow the instructions on the display (p. 41). (If the caller has no name information, see page 41, from step 3.)

➡ Using the Caller List

The Caller ID Number Auto Edit Feature

There are 3 patterns of phone number (Ⓐ, Ⓑ, and Ⓒ, p. 39). This feature allows your phone to automatically edit an in-coming Caller ID number into one pattern you preferred, and display the Caller ID number with that pattern on the handset automatically.

After this feature is activated, Caller ID numbers coming from considered area codes (201, for example), from which the Caller ID numbers have been chosen to follow the desired pattern (7 digit pattern, for example), will be automatically edited from other patterns (11 digit pattern, for example) into the same pattern you have previously selected (which is 7 digit pattern, in the example).

Up to 4 area codes are allowed for this feature for pattern Ⓐ and Ⓑ (p. 39).

To activate this feature, you must 1) set this feature to on, and 2) make an out-going call from Caller List (p. 38) with a number which has one of 3 patterns that you have edited with considered area code, and that you prefer to be followed by future Caller ID numbers, so that in the future all the Caller ID numbers coming from the same area code will be displayed in the same pattern.

The Caller ID number Auto Edit feature is preset to ON at factory.

- If you fail to reach your destination when making the call, the phone number you dialed might have an incorrect pattern, please edit the phone number with another pattern (p. 39).

For example, if you move to another area, you may need to turn this feature to OFF to erase previously edited area codes. Then, if still need, you may activate this feature again.

Make sure the unit is not being used and the handset is lifted off the base unit.

1. Press **FUNCTION/2WAY REC**.
2. Scroll to "Program" by pressing **▼** or **▲** and press **▶**.
3. Scroll to "CallerID edit" by pressing **▼** or **▲**.
4. Press **▶**.
5. Select "On" or "Off" by pressing **▼** or **▲**.
6. Press **▶** (Save key).
 - A beep sounds.
 - To exit the programming mode, press **OFF**.

Ringer pattern
▶Program

Talk switching
▶CallerID edit
LCD contrast

- When the feature is set to OFF, the unit will still be able to display Caller ID, like regular Caller ID telephone, but the in-coming Caller ID number will not be edited by pattern and by area codes.



Storing Caller List Information in the Directory

You can store phone numbers that are in the Caller List into the directory. **Make sure the unit is not being used and the handset is lifted off the base unit.**

1 Press or to enter the Caller List.

```
10 new calls
▼▲ ▶=Directory
```

2 Scroll to the caller you want to store in the directory by pressing or , and press .

```
TURNER, CINDY
1-234-456-7890
11:20A JAN12 X3
```

•If the number requires editing, see page 39.

```
▶Edit
Save directory
▼▲ ▶=Yes
```

3 Scroll to “Save directory” by pressing or , and press .

```
Edit
▶Save directory
▼▲ ▶=Yes
```

If there is no name information for the caller, “Enter name” will be displayed.

- a) If a name is not required, press (Next key) and press (Save key).
- b) If a name is required, enter the name (p. 45). When finished, press (Next key) and press (Save key).

```
Enter name
█
◀▶ ▼=Next
```

```
Enter name
CINDY TURNER
█
◀▶ ▼=Next
```

- A beep sounds.
- To continue storing other items, repeat from step 2.
- To exit the programming mode, press **OFF**.

```
CINDY TURNER
1-234-456-7890
```

- You can exit the programming mode any time by pressing **OFF**.
- If the display shows “Directory full” in step 3, press **OFF** to exit the list. To erase other stored items from the directory, see page 50.
- You cannot store caller information in the directory if a phone number is not displayed.
- If an alarm tone sounds in step 3, the item cannot be stored in the directory. Place the handset on the base unit and try again from step 1.

➔ Using the Caller List

Erasing Caller List Information

After checking the Caller List, you can erase some or all of the entries. **Make sure the unit is not being used and the handset is lifted off the base unit.**

To erase a specific caller from the Caller List

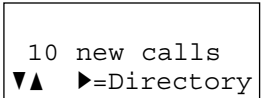
- 1 Press **▼** or **▲** to enter the Caller List.

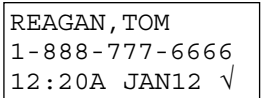
```
10 new calls
▼▲ ▶=Directory
```
- 2 Scroll to the caller you want to erase from the Caller List by pressing **▼** or **▲**.

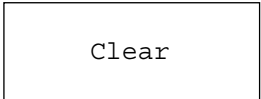
```
REAGAN, TOM
1-888-777-6666
12:20A JAN12 ✓
```
- 3 Press **HOLD/INTERCOM/CLEAR**.
 - A beep sounds and the information is erased.
 - To erase other items, repeat from step 2.
 - To exit the Caller List, press **OFF**.

```
Clear
```

To erase all entries in the Caller List

Before erasing all entries, make sure that “0 new call” is displayed.

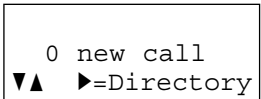
- 1 Press **▼** or **▲** to enter the Caller List.

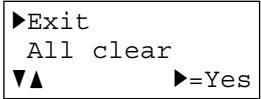
```
0 new call
▼▲ ▶=Directory
```
- 2 Press **HOLD/INTERCOM/CLEAR**.

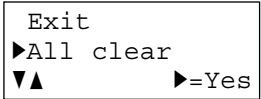
```
▶Exit
All clear
▼▲ ▶=Yes
```
- 3 Select “All clear” by pressing **▼** or **▲**.

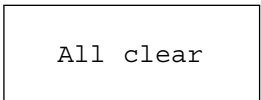
```
Exit
▶All clear
▼▲ ▶=Yes
```
- 4 Press **▶** (Yes key) or **HOLD/INTERCOM/CLEAR**.
 - A beep sounds and all entries are erased.
 - The handset will exit the Caller List.

```
All clear
```

Directory



You can store up to 50 names and phone numbers in the directory using the handset. All directory items are sorted by the first word in alphabetical order. Using the directory, you can make a call by selecting a name on the handset display.

Storing Names and Numbers

Make sure the unit is not being used and the handset is lifted off the base unit.

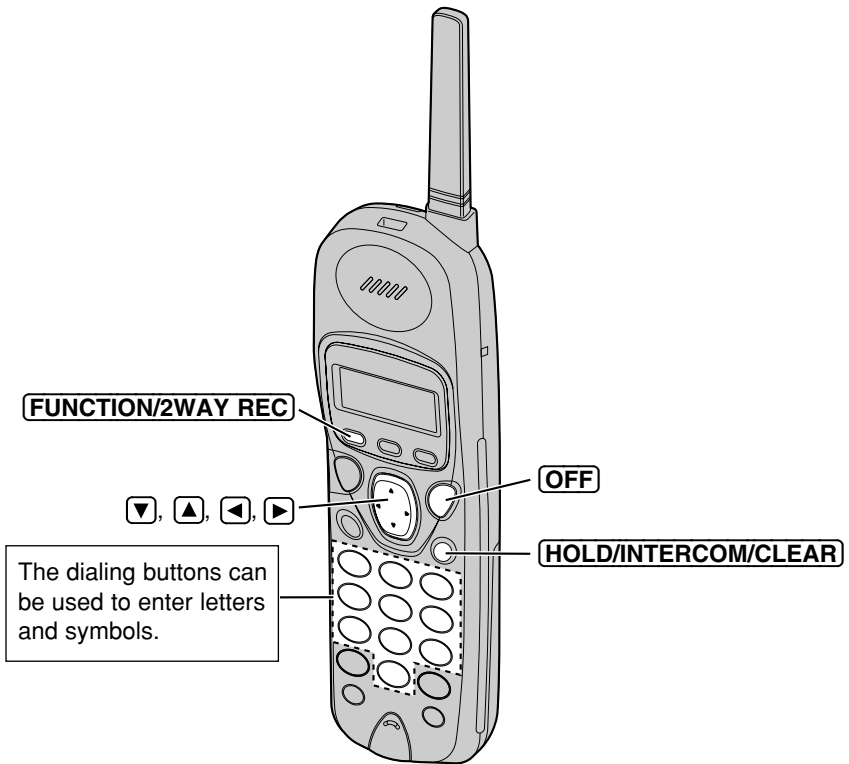

(Continued→)

➡ Directory

1 Press **FUNCTION/2WAY REC**.

```
-----  
▶Save directory  
Ringer volume
```

2 Press **▶** at “Save directory”.
•The display shows the number of stored items in the directory.

```
Directory=  
20 items
```

3 Enter a name, up to 15 characters with the dialing buttons, **◀** or **▶**.
•See the steps for entering names and symbols (p. 45).
•If a name is not required, press **▼** (Next key) and go to step 5.

```
Enter name  
█  
◀▶ ▼=Next
```

```
Enter name  
Tom Jones  
◀▶ ▼=Next
```

4 Press **▼** (Next key).

```
Enter phone no.  
  
  

```

5 Enter a phone number, up to 22 digits.
•Each time you press **HOLD/INTERCOM/CLEAR**, a digit is erased.
To erase all of the digits, press and hold **HOLD/INTERCOM/CLEAR**.

```
0987654321 █  
◀▶ ▼=Next
```

6 Press **▼** (Next key).
•If you want to change the storing name or number, press **▲** (Edit key) repeatedly to reach the desired display and change it.

```
Tom Jones  
098-765-4321  
▲=Edit ▶=Save
```

7 Press **▶** (Save key).
•A beep sounds.
•To continue storing other items, repeat from step 2.
•To exit the programming mode, press **OFF**.

```
Tom Jones  
098-765-4321
```

- If a pause is required for dialing, **REDIAL/PAUSE** can be stored in a phone number counting as one digit (p. 54) in step 5.
- You can exit the programming mode any time by pressing **OFF**.
- If the display shows “Directory full” in step 2, the display will return to step 1, press **OFF** to exit the programming mode. To erase other stored items from the directory, see page 50.
- If an alarm tone sounds in step 7, the item cannot be stored in the directory. Place the handset on the base unit and try again from step 1.



Entering Names and Symbols

The handset dialing buttons (0 to 9), ◀ and ▶ can be used to enter letters and symbols. The letters are printed on the dialing buttons. Pressing each button selects a character as shown below.

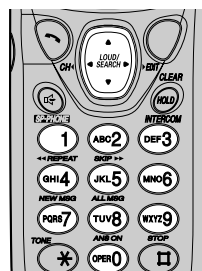

Keys	Number of times key is pressed										
	1	2	3	4	5	6	7	8	9	10	11
1	#	&	'	()	*	,	-	.	/	1	
2	a	b	c	A	B	C	2				
3	d	e	f	D	E	F	3				
4	g	h	i	G	H	I	4				
5	j	k	l	J	K	L	5				
6	m	n	o	M	N	O	6				
7	p	q	r	s	P	Q	R	S	7		
8	t	u	v	T	U	V	8				
9	w	x	y	z	W	X	Y	Z	9		
0	0	Blank									
◀	To move the cursor to the left										
▶	To move the cursor to the right										







•To enter another character using the same dialing button, press ▶ to move the cursor to the next space.

If you make a mistake while entering a name

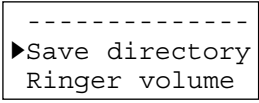
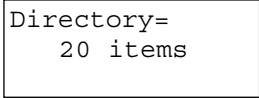
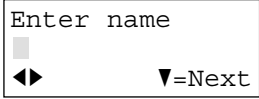
Use ◀ or ▶ to move the cursor to the incorrect character, press **HOLD/INTERCOM/CLEAR** to delete and enter the correct character. Each time you press **HOLD/INTERCOM/CLEAR**, a character is erased. To erase all characters, press and hold **HOLD/INTERCOM/CLEAR**.

➡ Directory

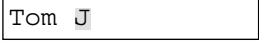
For example, to enter “Tom Jones”:

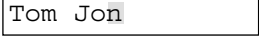
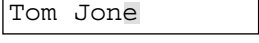
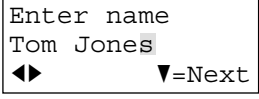
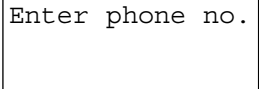
- 1 Press **[FUNCTION/2WAY REC]**.

- 2 Press **[▶]** at “Save directory”.

- 3 Press **[8]** four times.

- 4 Press **[6]** three times, then press **[▶]** to move the cursor to the right.

- 5 Press **[6]**.

- 6 Press **[▶]** twice to enter a blank.

- 7 Press **[5]** four times.

- 8 Press **[6]** three times, then press **[▶]** to move the cursor to the right.

- 9 Press **[6]** twice.

- 10 Press **[3]** twice.

- 11 Press **[7]** four times.

- 12 When finished, press **[▼]** (Next key).
 - Follow steps 5 to 7 on page 44 to complete the operation.

•While entering names, the cursor will flash on the display.



Finding Stored Items

You can search the directory using the handset.

Make sure the unit is not being used and the handset is lifted off the base unit.

1 Press or to enter the directory list.

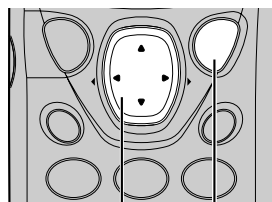
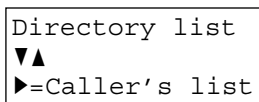

- You can go to the Caller List by pressing (p. 37).

2 Press or .

- The first item is displayed.

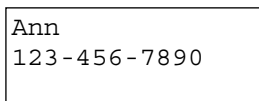

3 Scroll to the desired caller by pressing or .

- All directory items are stored in the order shown on the right.

To search for a name by initial

- ① Press the dialing button for the first letter of the desired name until any name with the same initial is displayed (see the Index table on the page 48).
Ex. To find "Frank", press **3** repeatedly until the first item under "F" is displayed.

- ② Press repeatedly until the name is displayed.

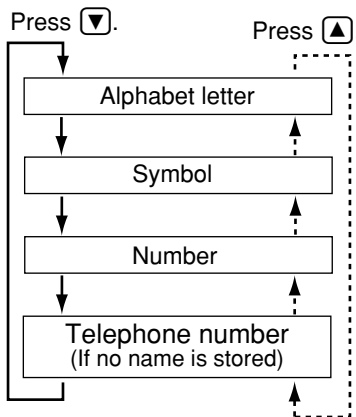

- You can exit the directory list any time by pressing **OFF**.

- If "No items stored" is displayed in step 2, the directory list is empty.



➔ Directory

Index table



Keys	Index	Keys	Index
①	Other symbols, 1	⑥	M, N, O, 6
②	A, B, C, 2	⑦	P, Q, R, S, 7
③	D, E, F, 3	⑧	T, U, V, 8
④	G, H, I, 4	⑨	W, X, Y, Z, 9
⑤	J, K, L, 5	⑩	0

Dialing



Make sure the unit is not being used and the handset is lifted off the base unit.

1 Press  or  to enter the directory list.

Directory list
▼▲
▶=Caller's list



2 Press  or .

- The first item is displayed.

3 Scroll to the desired item that you want to dial by pressing  or .

- To search for the item by initial, see page 47.
- To exit the directory list, press **OFF**.

Frank
456-7890

4 Press  or .

- The number is dialed automatically.

Ex.  was pressed.

Talk
4567890

5 To hang up, press **OFF** or place the handset on the base unit.

- You can exit the directory list any time by pressing **OFF**.



Editing

Make sure the unit is not being used and the handset is lifted off the base unit.

1 Press ◀ or ▶ to enter the directory list.

2 Press ▼ or ▲.
•The first item is displayed.

3 Scroll to the directory item you want to change by pressing ▼ or ▲, and press ▶.
•To search for the item by initial, see page 47.
•If you do not need to change the name, go to step 5.

Jane
456-7890

Enter name
Jane
◀ ▶ ▼=Next

4 Edit the name using the dialing buttons, ◀ or ▶ (p. 45), up to 15 characters.

Enter name
Jane Walker
◀ ▶ ▼=Next

5 Press ▼ (Next key).

4567890
◀ ▶ ▼=Next

6 Add a number to the current number.
•If you do not need to change the number, press ▼ (Next key) and go to step 8.
•Each time you press **HOLD/INTERCOM/CLEAR**, a digit is erased.
To erase all digits, press and hold **HOLD/INTERCOM/CLEAR**.

12344567890
◀ ▶ ▼=Next

7 Press ▼ (Next key).
•If you want to change the storing name or number, press ▲ (Edit key) repeatedly to reach the desired display and change it.

Jane Walker
1-234-456-7890
▲=Edit ▶=Save

8 When finished, press ▶ (Save key).
•A beep sounds.
•To continue editing other items, repeat from step 3.
•To exit the directory list, press **OFF**.



Jane Walker
1-234-456-7890



•You can exit the edit mode any time by pressing **OFF**.

➡ Directory



Erasing

Make sure the unit is not being used and the handset is lifted off the base unit.

1 Press  or  to enter the directory list.

2 Press  or .

- The first item is displayed.

3 Scroll to the directory item that you want to erase by pressing  or .

- To search for the item by initial, see page 47.

Helen 1-234-567-8901

4 Press **HOLD/INTERCOM/CLEAR**.

- To stop erasing, press  (No key).

Clear?
◀=No ▶=Yes

5 Press  (Yes key) or **HOLD/INTERCOM/CLEAR**.

- A beep sounds and the item is erased.
- To erase other items, repeat from step 3.
- To exit the programming mode, press **OFF**.

Clear

•You can exit the programming mode any time by pressing **OFF**.

Intercom



A 2-way intercom is possible between the handset and the base unit.

Paging the base unit from the handset

- 1 Handset:
Press **HOLD/INTERCOM/CLEAR**.
Talk to the paged party after the beeps.
•“Intercom” is displayed.

- 2 Base unit:
When the other party's voice is heard, answer using the **MIC**.

- 3 To end the intercom, press **OFF** on the handset.
OR
Press **LOCATOR/INTERCOM** on the base unit.

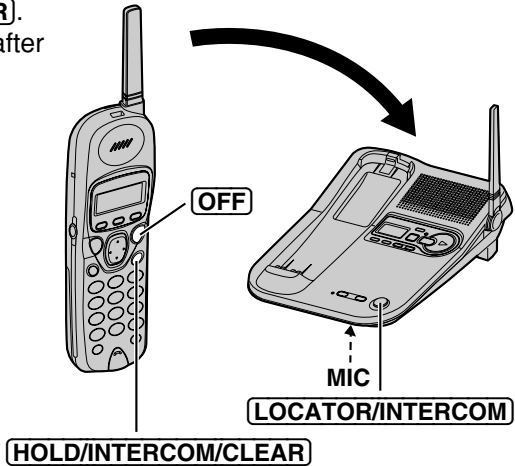

➔ Intercom

Paging the handset from the base unit (Handset locator)

Using this feature, you can also locate a misplaced handset.

- 1 Base unit:
Press **LOCATOR/INTERCOM**.
 - The handset beeps for 1 minute and displays “Paging Press INTERCOM”.
 - To stop paging, press **LOCATOR/INTERCOM** on the base unit.

- 2 Handset:
Press **HOLD/INTERCOM/CLEAR** to answer.
 - “Intercom” is displayed.

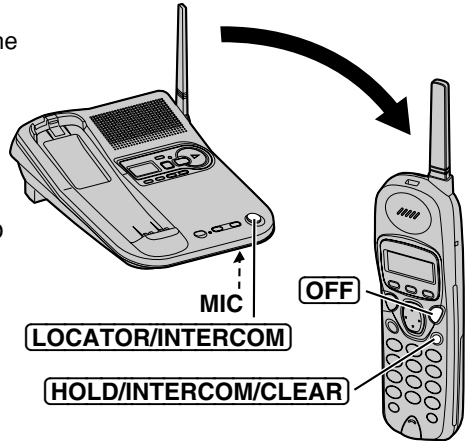



- 3 Base unit:
Talk into the **MIC**.

- 4 To end the intercom, press **OFF** on the handset.
OR
Press **LOCATOR/INTERCOM** on the base unit.

•If you do not want to answer the page in step 2, press **OFF** to stop beeping.

During an intercom call:

- If the handset user has difficulty hearing the base unit user, decrease the base unit speaker volume by pressing **VOLUME** .
- If an incoming call is received, the intercom call stops and the unit starts to ring. To answer, press  or .

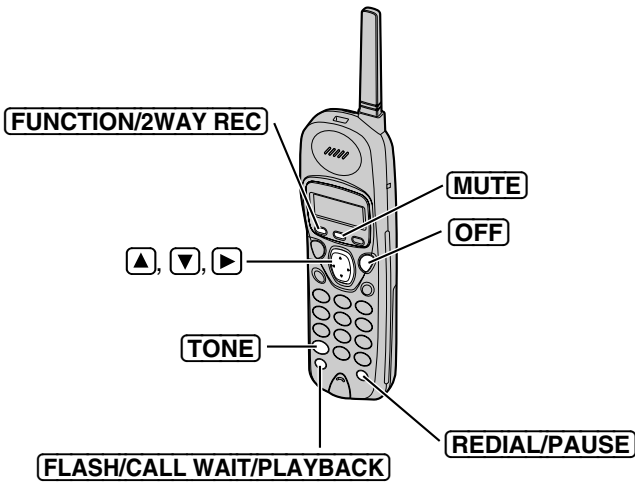

Automatic Security Code Setting

Each time you place the handset on the base unit, the unit automatically selects one of more than a million security codes. These codes help prevent the unauthorized use of your telephone line by another cordless telephone user.

Temporary Tone Dialing (For Rotary or Pulse Service Users)

Press **TONE** before entering access numbers which require tone dialing.

- The dialing mode changes to tone. You can enter numbers to access an answering service, electronic banking service, etc. When you hang up, the mode will return to pulse.

Muting Your Conversation

Press **MUTE** while talking.

- The display on the right will be shown.

Ex. **MUTE** was pressed.

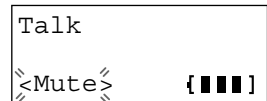

- The other party cannot hear your voice but you can hear theirs.
- To release the mute, press **MUTE**, or .

➡ Special Features

For Call Waiting Service Users

Press **FLASH/CALL WAIT/PLAYBACK** if you hear a call-waiting tone while talking.

- The first call is put on hold and you can answer the second call.
- To return to the first caller, press **FLASH/CALL WAIT/PLAYBACK** again.
- The call waiting service cannot be used when:
 - the answering system is recording someone's message or
 - a parallel connected telephone is in use.
- If this function does not operate properly, consult your telephone company for details.

Call Waiting Caller ID Feature

Call Waiting Caller ID Feature allows your handset to display the second caller's information. After you hear a call-waiting tone while talking, the handset will display the caller's name with the phone number and "----Waiting----".

BROWN, NANCY 1-555-666-7777 ----Waiting----

- Please contact your telephone company for details and availability in your area.

How to Use the PAUSE Button (For Analog PBX Line/Long Distance Service Users)

We recommend you press **REDIAL/PAUSE** if a pause is required for dialing with a PBX or to access a long distance service.

Ex. Line access number **9** (PBX)

9 → **REDIAL/PAUSE** → Phone number

- Pressing **REDIAL/PAUSE** once creates a 3.5 second pause. This prevents misdialing when you redial or dial a stored number.
- Pressing **REDIAL/PAUSE** more than once increases the length of the pause between numbers.

FLASH Button

Pressing **FLASH/CALL WAIT/PLAYBACK** allows you to use special features of your host PBX such as transferring an extension call or accessing special telephone services (optional) such as call waiting.

- Pressing **FLASH/CALL WAIT/PLAYBACK** causes to release following operations:
 - temporary tone dialing,
 - muting your conversation, or
 - recording your conversation.

Selecting the flash time

The flash time depends on your telephone exchange or host PBX. You can select the following flash times: “700, 600, 400, 300, 250, 110, 100 or 90 ms (milliseconds)”. Your phone comes from the factory set to “700 ms”.

Make sure the unit is not being used and the handset is lifted off the base unit.

1 Press **FUNCTION/2WAY REC**.

2 Scroll to “Program” by pressing **▼** or **▲**.

```
Ringer pattern
▶Program
-----
```

3 Press **▶**.

4 Scroll to “Set flash time” by pressing **▼** or **▲**.

```
TAD program
▶Set flash time
Set line mode
```

5 Press **▶**.
•The current setting is displayed.

```
Flash time
:700ms
▼▲ ▶=Save
```

6 Select the desired time by pressing **▼** or **▲**.

7 Press **▶** (Save key).

- A beep sounds.
- To exit the programming mode, press **OFF**.

```
Flash time
:110ms
```

- You can exit the programming mode any time by pressing **OFF**.
- If the unit is connected via a PBX, PBX functions (transferring a call etc.) might not work correctly. Consult your PBX supplier for the correct setting.

Automatic Answering Operation

When the unit answers a call, a greeting message is played and the caller's message is recorded.

- The total recording time (including greeting message) is **about 15 minutes**. If messages are recorded in noisy rooms, the time may be shortened by up to 3 minutes.
- A maximum of 64 messages (including greeting message) can be recorded.

Setting the Unit to Answer Calls

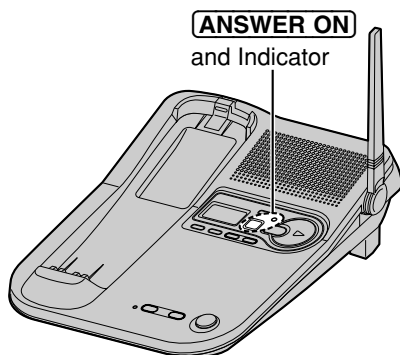

Press **ANSWER ON** to turn on the answering system.

- The indicator lights and "Answer set" is heard.
- The unit will announce the remaining recording time if it is less than 5 minutes.
- If you hear "Memory full", "**FULL**" is displayed on the base unit and the ANSWER ON indicator flashes rapidly, erase some, or all, of the messages (p. 60).



- If you do not want the unit to answer calls, press **ANSWER ON** again to turn off the answering system. The indicator light goes out and "Answer off" is heard.
- You can also turn on the answering system remotely using any other phone (p. 67).

Monitoring incoming calls

While a call is being recorded, you can monitor it through the speaker. To answer the call, press  or . The unit stops recording.

Listening to Messages



You can see the total number of recorded messages on the base unit display. If MESSAGE PLAYBACK indicator flashes, new messages have been recorded.

To play back messages, press **MESSAGE PLAYBACK/SLOW TALK**.

When you have new messages: the unit announces the number of new messages and only new messages are played back.

When you have no new messages: the unit announces “No new messages. All message playback” and plays back all messages.

When you have no messages: the unit announces “No messages”.

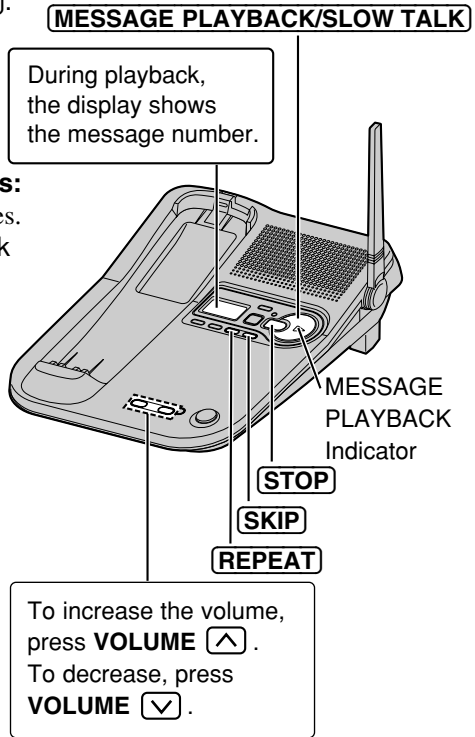

At the end of the last message, “End of final message” is heard. The unit will announce the remaining recording time if it is less than 5 minutes.

Slow Talk Message Playback

For easier listening of recorded messages, you can slow down the playback speed by pressing **MESSAGE PLAYBACK/SLOW TALK** during playback. Each time you press the button, the playback speed will change to slow/normal.

Press **MESSAGE PLAYBACK/SLOW TALK** during playback.

- The playback speed will slow down by 30%.
- To return to the normal speed, press **MESSAGE PLAYBACK/SLOW TALK** again during playback.
- The playback speed will return to normal after playing back all messages.

➔ Listening to Messages

During playback



To repeat message	Press REPEAT . •If you press within 5 seconds of playback, the previous message will be played.
To skip message	Press SKIP .
To stop operation	Press STOP . •To resume playback, press MESSAGE PLAYBACK/SLOW TALK . •If you do not press any button for 60 seconds or if you press STOP again, the playback mode will be canceled.

For Caller ID service users (p. 35)

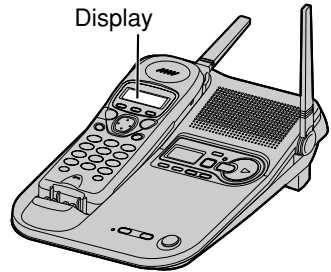
During playback, when the handset is on the base unit, the handset display will show the name and/or number of the caller whose message is being played.



To call back the displayed number:

During playback, lift the handset and press  or  within 10 seconds.

—The unit stops playback and automatically dials the displayed phone number.

- After listening to new incoming messages, “√” will be added to the call entries in the Caller ID Caller List (p. 37).

From the Handset

If someone else is in the room and you want to listen to the recorded messages privately, you can use the handset.

1 Handset:
Press **FLASH/CALL WAIT/PLAYBACK**.

- The number of new messages is heard on the handset.
- “Remote operation” will be displayed.

2 Base unit:
To listen to messages:
Press **MESSAGE PLAYBACK/SLOW TALK**.

When you have new messages:

the unit announces the number of new messages and only new messages are played back.

When you have no new messages:

the unit announces “No new messages. All message playback” and plays back all messages.

When you have no messages:

the unit announces “No messages”.

- The messages will be heard on the handset.
- MESSAGE PLAYBACK/SLOW TALK**, **REPEAT**, **SKIP** and **STOP*** can also be used during playback (p. 58).



3 When finished, press **FLASH/CALL WAIT/PLAYBACK** or place the handset on the base unit.

- You can also listen to messages without using the base unit. See page 68.

*When you press **STOP** during playback, operation is stopped.

To resume the playback, press **MESSAGE PLAYBACK/SLOW TALK** within 15 seconds, or the voice menu will start (p. 68).

Erasing Messages

The unit will announce the remaining recording time after playback, if it is less than 5 minutes. New messages cannot be recorded when:

- “Memory full” is heard.
- “**FULL**” is displayed on the base unit.
- the ANSWER ON indicator flashes rapidly.

Erase some, or all, of the messages. We recommend you erase unnecessary messages after each playback.

Erasing a specific message

Press **ERASE** while the message you want to erase is being played.

- The unit erases the message.
- A short beep will sound and the unit will continue to play the next message.

Erasing all messages

All recorded messages, except the greeting message, can be erased at one time.

- 1 Press **ERASE**.
 - “To erase all messages, press ERASE again” is heard.
- 2 Within 5 seconds, press **ERASE** again.
 - A long beep sounds and “No messages” is heard.
 - The base unit display shows “0”.

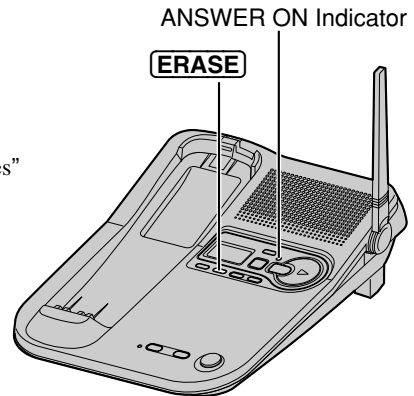

- The information in the Caller List will not be erased. To erase Caller List information, see page 42.

Recording a Memo Message

You may record a personal message in memory.

- 1 Press **MEMO**.
 - A long beep sounds.
- 2 After the beep, talk clearly approximately 8 inches (20 cm) away from the **MIC**.
 - The base unit display shows the elapsed recording time.
- 3 When finished, press **MEMO** or **STOP**.
 - A beep sounds.
 - The MESSAGE PLAYBACK indicator flashes.

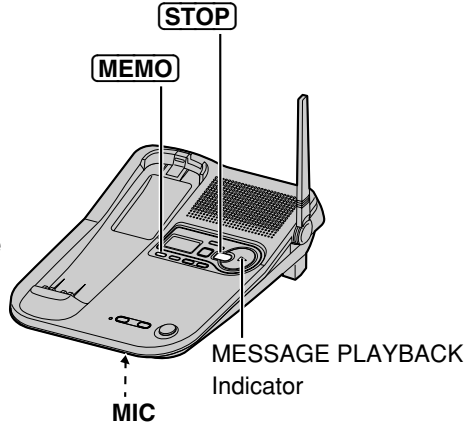

Recording Your Telephone Conversation

- 1 During a conversation with the handset, press **FUNCTION/2WAY REC**.
 - “2way record” is displayed on the handset.
 - The base unit display shows the elapsed recording time.
- 2 Continue your conversation.
- 3 When finished recording the conversation, press **FUNCTION/2WAY REC**.
 - The MESSAGE PLAYBACK indicator flashes.

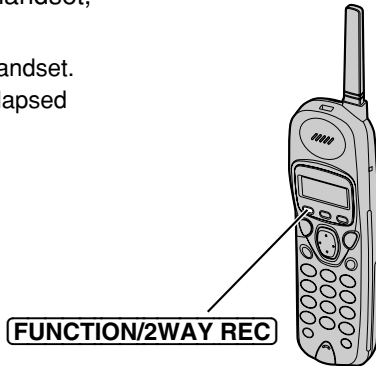

•While recording your conversation, Call Waiting Caller ID feature cannot be used.

Many states have imposed regulations on the manner in which 2-way telephone conversations may be recorded, so you should inform the other party that the conversation is being recorded. Consult your local telephone company for further information.

Remote Operation from a Touch Tone Phone

You can operate the answering system from any touch tone phone. A synthesized voice menu will guide you on how to operate the unit (p. 64).

- To skip the voice menu and operate the unit directly, see page 66.

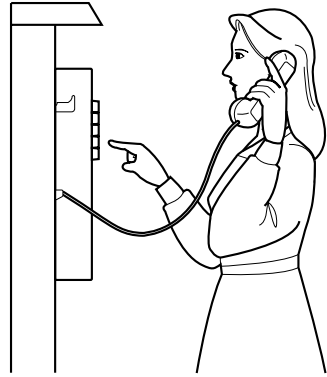

Summary of remote operation

Call your unit from a touch tone phone.



Enter your remote code (p. 63) during or after the greeting message.
•The number of new messages is heard.



After 3 seconds, the voice menu will start (p. 64).
Follow the menu or enter the direct commands (p. 66).



To end remote operation, hang up.
•The messages are saved.

- The unit will announce the remaining recording time after playback, if it is less than 5 minutes.



Remote Code

The remote code prevents unauthorized people from accessing your unit and listening to your messages. Choose any **2-digit number (00–99)**. The factory preset remote code is “11”. If you do not program your own remote code, you can use “11”.

Make sure the unit is not being used and the handset is lifted off the base unit.

1 Press **FUNCTION/2WAY REC**.

```
-----
▶Save directory
Ringer volume
```

2 Scroll to “Program” by pressing **▼** or **▲**.

```
Ringer pattern
▶Program
-----
```

3 Press **▶**.

```
-----
▶TAD program
Set flash time
```

4 Press **▶** at “TAD program”.

```
-----
▶Day and time
Remote code
```

5 Scroll to “Remote code” by pressing **▼** or **▲**.

```
Day and time
▶Remote code
Number of ring
```

6 Press **▶**.
•The current setting is displayed.

```
Remote code
:11
▶=Save
```

7 Enter a remote code using a **2-digit number (00–99)**.

8 Press **▶** (Save key).
•A beep sounds from the base unit.
•To exit the programming mode, press **OFF**.

```
Remote code
:35
```

•You can exit the programming mode any time by pressing **OFF**.

To check the remote code

Repeat steps 1 to 6.

•The current remote code is displayed on the handset. When finished, press **OFF**.

➔ Remote Operation from a Touch Tone Phone

Voice Menu

The shaded boxes are voice prompts.

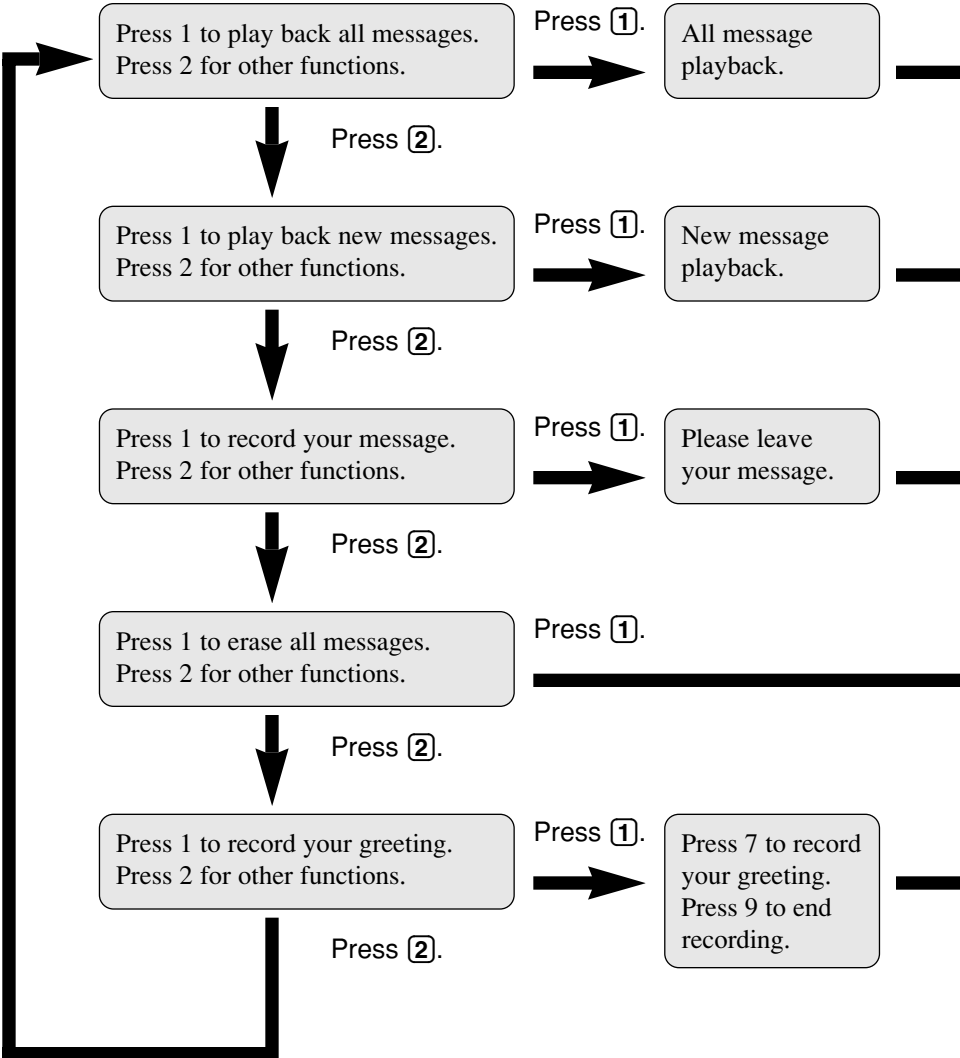



All Message Playback

All recorded messages are played back. At the end of the last message, "End of final message" is heard. The unit will announce the remaining recording time if it is less than 5 minutes.

New Message Playback

Only new messages are played back. At the end of the last message, "End of final message" is heard. The unit will announce the remaining recording time if it is less than 5 minutes.

Recording a Memo Message

You can leave a personal message.

1. Talk after you hear "Please leave your message".
2. When you finish recording, hang up.

Erasing All Messages

All recorded messages (except greeting message) are erased.

Recording a Greeting Message

You can re-record your greeting message.

1. Press **[7]**.
You will hear a voice prompt followed by a long beep.
2. After the beep, talk for up to 2 minutes.
3. When you finish recording, press **[9]**.
4. Your greeting will be played back for confirmation.

- 3 seconds after playback, the voice menu will start again from the beginning.
- If you hear "Memory full" after playback, erase some, or all, of the messages (p. 67).

➡ Remote Operation from a Touch Tone Phone

Direct Remote Operation

Once you have entered the remote code, you can also control your unit by direct commands instead of using the voice menu. To end the remote operation, hang up anytime.

Direct commands

NEW MESSAGE PLAYBACK	4	<ul style="list-style-type: none">•Only new messages are played back.
ALL MESSAGE PLAYBACK	5	<ul style="list-style-type: none">•All messages are played back.
REPEAT (During playback)	1	<ul style="list-style-type: none">•The current message is repeated.•If you press within 5 seconds of playback, the previous message will be played.
SKIP (During playback)	2	<ul style="list-style-type: none">•The current message is skipped. The next message is played.
CHANGING PLAYBACK SPEED (During playback)	3	<ul style="list-style-type: none">•Each time you press the button, the playback speed will change to slow/normal.
STOP	9	<ul style="list-style-type: none">•Operation is stopped temporarily.•To resume operation, enter a direct command within 15 seconds, or the voice menu will start.
GREETING MESSAGE RECORDING	7	<ul style="list-style-type: none">•A long beep sounds.
	↓	
RECORD		<ul style="list-style-type: none">•After the beep, talk immediately for up to 2 minutes.
	↓	
	9	<ul style="list-style-type: none">•The recording is stopped.•The recorded message is played.

ERASING A
SPECIFIC
MESSAGE
(During playback)

***** **4**

- The current message is erased.
- A short beep will sound and the next message will be played.

ERASING ALL
MESSAGES

***** **5**

- All recorded messages are erased.
- A long beep sounds and “No messages” is heard.

ANSWERING
SYSTEM OFF

0

- The unit hangs up and will not answer calls until turned on again.
-

Turning on the answering system

Call your unit and wait for 15 rings.

- The unit will answer and the greeting message will be played.
- The answering system will turn on. Hang up or enter the remote code for other options.
- When turning on the answering system using a rotary or pulse service telephone, you cannot enter the remote code for other options.

Skipping the greeting message

After calling your unit, press ***** during the greeting message.

- The unit skips the rest of the greeting message and you can start recording your message after the long beep.

Remote Operation with the Handset

You can operate your answering system with the handset.

The announcements and recorded messages can only be heard with the handset.

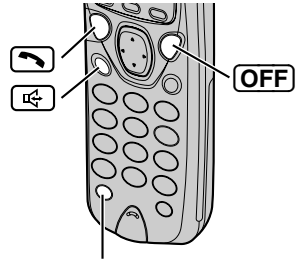

FLASH/CALL WAIT/PLAYBACK

Summary of remote operation

Press **FLASH/CALL WAIT/PLAYBACK**.

- The number of new messages is heard.
- “Remote operation” is displayed on the handset.



To listen to the announcements and messages from the speaker, press **while they are heard.**

- To switch back to the receiver, press .

Enter the desired direct commands (p. 69).

- If you do not enter a command, the voice menu will start (see below).
- After the voice menu, all message playback will start.



To end remote operation, press **FLASH/CALL WAIT/PLAYBACK** or **OFF**.

- The messages are saved.

- The unit will announce the remaining recording time after playback, if it is less than 5 minutes.
- If the unit starts to ring during the remote operation, press or to answer the call. The remote operation is ended.
- If you hear “Memory full” after playback, erase some, or all, of the messages (p. 69).

Voice menu

If no commands are entered after you press **FLASH/CALL WAIT/PLAYBACK**, the unit will start the following voice menu.

“Press 4 to play back new messages. Press 5 to play back all messages.”

- You can enter direct commands even if the voice menu has started.

Direct commands

NEW MESSAGE PLAYBACK	4	<ul style="list-style-type: none"> •Only new messages are played back.
ALL MESSAGE PLAYBACK	5	<ul style="list-style-type: none"> •All messages are played back.
REPEAT (During playback)	1	<ul style="list-style-type: none"> •The current message is repeated. •If you press within 5 seconds of playback, the previous message will be played.
SKIP (During playback)	2	<ul style="list-style-type: none"> •The current message is skipped. The next message is played.
CHANGING PLAYBACK SPEED (During playback)	3	<ul style="list-style-type: none"> •Each time you press the button, the playback speed will change to slow/normal.
STOP	9	<ul style="list-style-type: none"> •Operation is stopped temporarily. •To resume operation, enter a direct command within 15 seconds, or the voice menu will start (p. 68).
ERASING A SPECIFIC MESSAGE (During playback)	* 4	<ul style="list-style-type: none"> •The current message is erased. •A short beep will sound and the next message will be played.
ERASING ALL MESSAGES	* 5	<ul style="list-style-type: none"> •All recorded messages are erased. •A long beep sounds and “No messages” is heard.
ANSWERING SYSTEM OFF	0	<ul style="list-style-type: none"> •“Answer off” is heard and the answering system is turned off.
ANSWERING SYSTEM ON	8	<ul style="list-style-type: none"> •“Answer set” is heard and the answering system is turned on.

Wall Mounting

This unit can be mounted on a wall phone plate.

- 1 Push the hook and turn it around.
Turn the hook until a click is heard.

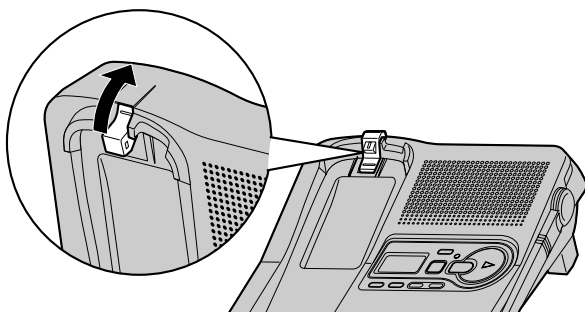

- 2 Connect the AC adaptor.

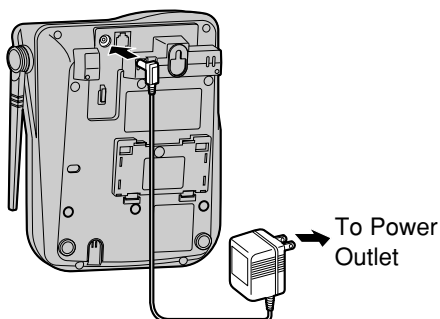

- 3 Tuck the telephone line cord inside the wall mounting adaptor, then push it in the direction of the arrow.
 - The word "UP" should face upward.

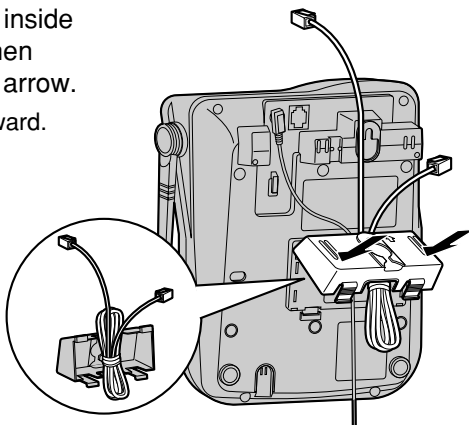

4 Connect the telephone line cord.
Mount the unit, then slide down.

- Raise the antenna.
- Fasten the telephone line cord to prevent it from being disconnected.

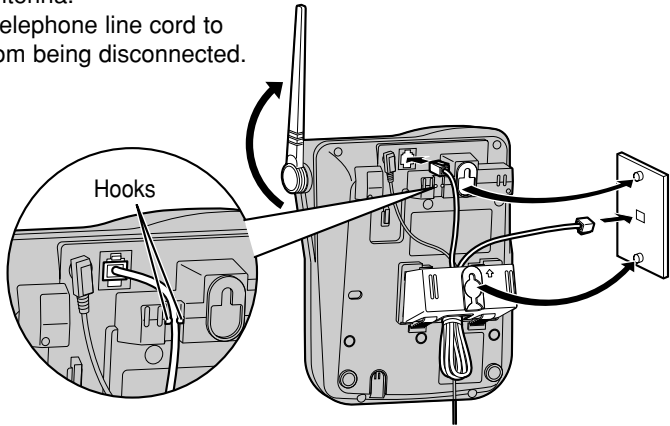

5 **To charge the handset battery:**
Fix the charge contacts (①) and insert
the hook to the handset hole (②).

- The IN USE/CHARGE/HOLD indicator lights.

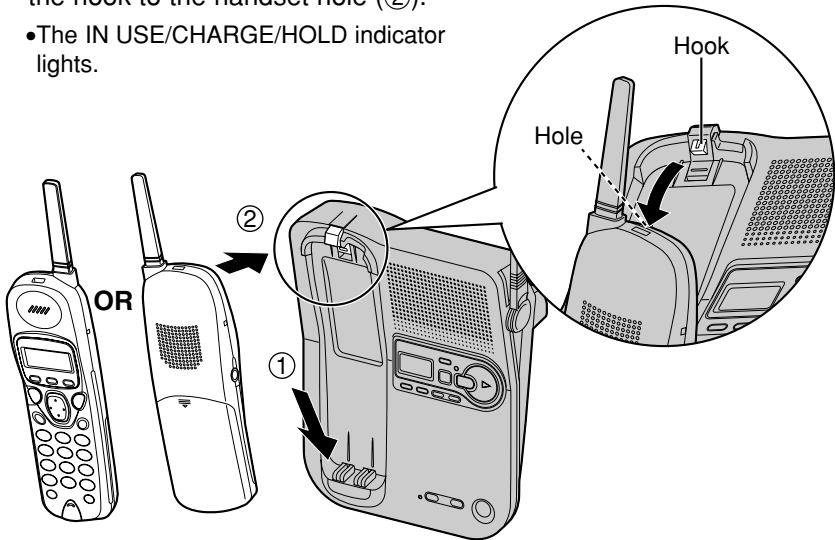

Belt Clip

You can hang the handset on your belt or pocket using the belt clip.

To attach the belt clip

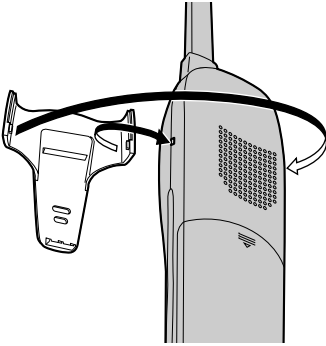

To remove the belt clip





Optional Headset

Plugging an optional headset into the handset allows a hands-free phone conversation. Please use only a Panasonic KX-TCA88 or KX-TCA90 headset. To order, call the accessories telephone number on page 2.

Connecting an optional headset to the handset

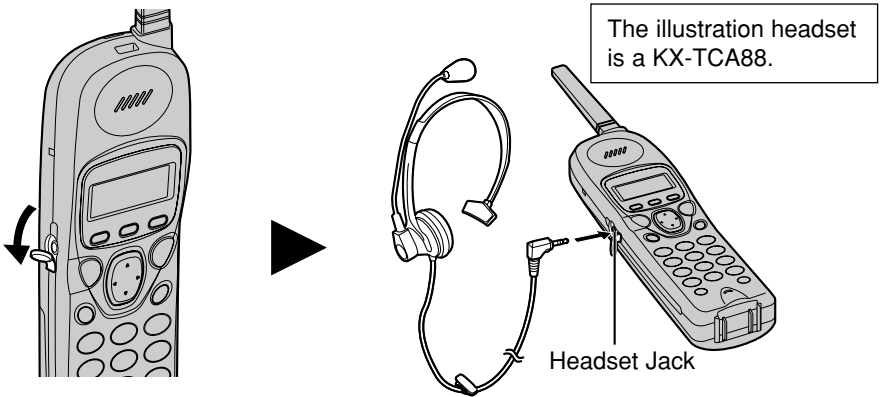
Open the headset jack cover, and connect an optional headset to the headset jack as shown below.



To switch to the speakerphone while using the headset:
Press . To return to the headset, press .

Battery Replacement

If “Recharge” is displayed and/or “[■]” flashes after being fully charged, replace the battery with a new Panasonic P-P511 (PQPP511SVC) battery. To order, call the accessories telephone number on page 2.

- 1 Press the notch on the handset cover firmly and slide it as indicated by the arrow.

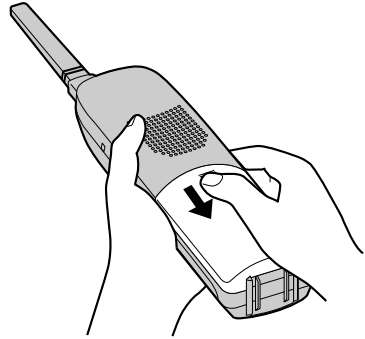

- 2 Remove the old battery. Insert the new battery into the handset as shown (①), matching the correct polarity. Press the battery down until it places into the compartment (②).

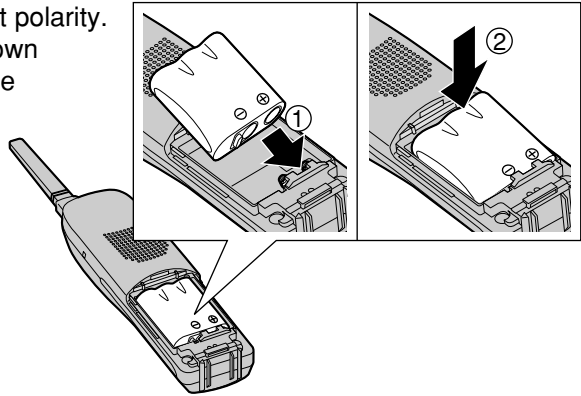

- 3 Close the cover. Make sure you charge the new battery for about 15 hours in order to display the battery strength prompt correctly (p. 14).

A nickel cadmium battery that is recyclable powers the product you have purchased. At the end of its useful life, under various state and local laws, it is illegal to dispose of this battery into your municipal waste stream. Please call 1-800-8-BATTERY for information on how to recycle this battery.



Adding Another Phone

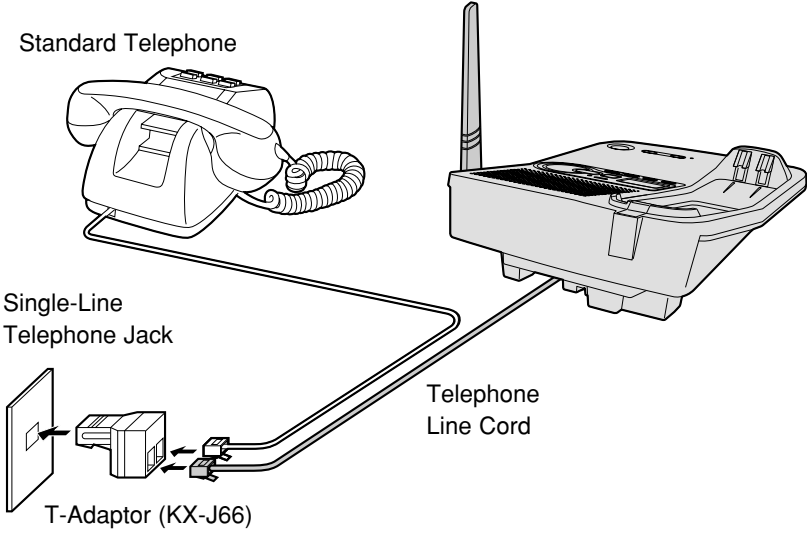

This unit will not function during a power failure. To connect a standard telephone on the same line, use the Panasonic T-adaptor KX-J66. To order, call the accessories telephone number on page 2.



Troubleshooting





Cordless Telephone

Problem	Remedy
“No link to base Place on cradle and try again.” is displayed and an alarm tone sounds.	<ul style="list-style-type: none">•You are too far from the base unit. Move closer and try again.•Place the handset on the base unit and try again.•Plug in the AC adaptor.•Raise the base unit antenna.
Static, sound cuts in/out, fades. Interference from other electrical units.	<ul style="list-style-type: none">•Locate the handset and the base unit away from other electrical appliances (p. 3).•Move closer to the base unit.•Raise the base unit antenna.•Press  to select a clearer channel in the talk, speakerphone, intercom or remote operation mode.
The unit does not ring.	<ul style="list-style-type: none">•The ringer volume is set to OFF. Set to HIGH or LOW (p. 20).
The handset display is blank.	<ul style="list-style-type: none">•Charge the battery fully (p. 14).
You cannot store a name and phone number in the directory.	<ul style="list-style-type: none">•You cannot store an item in the directory while the unit is in the talk, speaker or intercom mode or while the answering system is in use.•Do not pause for over 60 seconds while storing.
While programming or searching, the unit starts to ring and stops the program/search.	<ul style="list-style-type: none">•To answer the call, press  or . Start again from the beginning after hanging up.
You cannot make a call with the handset.	<ul style="list-style-type: none">•You cannot make a call when the unit is in the remote operation mode. Exit the mode by pressing OFF (p. 68).

➔ Troubleshooting

Problem	Remedy
The unit does not display the caller's name and/or phone number.	<ul style="list-style-type: none">•You need to subscribe to a Caller ID service.•Other telephone equipment may be interfering with your phone. Disconnect it and try again.•Other electrical appliances connected to the same outlet may be interfering with the Caller ID information.•Telephone line noise may be affecting the Caller ID information.
The handset display exits the Caller List.	<ul style="list-style-type: none">•Do not pause for over 60 seconds while searching.
When a second call is received during a conversation, the unit does not display the new caller's name and/or phone number.	<ul style="list-style-type: none">•The line mode selection is incorrect. See page 17.•The caller requested not to send his/her information. See page 35.
You cannot page the handset.	<ul style="list-style-type: none">•The handset is too far from the base unit.•The handset is engaged in an outside call, viewing the Caller List/directory list or listening to messages. Wait until the IN USE/CHARGE/HOLD indicator light goes out.
You cannot redial by pressing REDIAL/PAUSE .	<ul style="list-style-type: none">•If the last number dialed was more than 32 digits long, the number will not be redialed correctly.•The button has a double function as either redial or pause. It will redial the last number dialed if pressed at the outset of a call (p. 31). If another number has been dialed first, it will operate as a pause button (p. 54).
You pressed CALLER IQ in the talk or speakerphone mode.	<ul style="list-style-type: none">•To return to a normal phone conversation, press HOLD/INTERCOM/CLEAR.









Problem	Remedy
You cannot have a conversation using the headset.	<ul style="list-style-type: none">• Make sure that an optional headset is connected properly (p. 72).•  may have been pressed. If “SP-phone” is displayed on the handset, press  to continue the conversation with the headset.





Answering System

Problem	Remedy
The answering system is on, but incoming messages are not recorded.	<ul style="list-style-type: none">• The recording time is set to “Greeting only”. Select “1 minute”, “2 minutes” or “3 minutes” (p. 28).• Memory is full. Erase some, or all, of the messages (p. 60).
You cannot listen to the recorded messages.	<ul style="list-style-type: none">• Make sure that the unit is not being used.
“ FULL ” is displayed and the ANSWER ON indicator flashes rapidly, and no new messages are recorded.	<ul style="list-style-type: none">• Memory is full. Erase some, or all, of the messages (p. 60).
You cannot operate the answering system with the base unit.	<ul style="list-style-type: none">• The handset user is operating the answering system, or is engaged in an outside call. Wait until the IN USE/ CHARGE/HOLD indicator light goes out.
You cannot operate the answering system from a touch tone phone.	<ul style="list-style-type: none">• Make sure you enter the correct remote code.• The answering system may not respond if the tones are too short to activate the unit. Press each button firmly.• The answering system is off. Turn it on (p. 67).

➔ Troubleshooting

Problem	Remedy
You cannot operate the answering system with the handset.	<ul style="list-style-type: none">•Someone is operating the answering system.•You are too far from the base unit. Move closer to the base unit.•The unit is recording a message. To answer the call, press  or .
While recording a greeting message, the unit starts to ring and stops recording.	<ul style="list-style-type: none">•To answer the call, press  or . Start again from the beginning after hanging up.
During playback, the unit starts to ring and stops playback.	<ul style="list-style-type: none">•To answer the call, press  or . To resume playback, press MESSAGE PLAYBACK/SLOW TALK after hanging up.

General

Problem	Remedy
The unit does not work.	<ul style="list-style-type: none">•Check the settings (p. 13–17).•Charge the battery fully (p. 14).•Clean the charge contacts and charge again (p. 15).•Install the battery properly (p. 14).•Place the handset on the base unit and unplug the AC adaptor to reset. Plug in, and try again.•Re-install the battery and place the handset on the base unit (p. 73). Try again.
You cannot program items, such as the dialing mode.	<ul style="list-style-type: none">•Programming is not possible while the unit is in the talk or speakerphone mode, when viewing the Caller List/directory list, or while the answering system is in use.•Do not pause for over 60 seconds while programming.•Move closer to the base unit.•, ,  or  may have been pressed when you picked up the handset. Press OFF and try again.

Problem	Remedy
Previously programmed information is erased.	<ul style="list-style-type: none"> •If a power failure occurs, programmed information may be erased. Reprogram if necessary.
“Recharge” is displayed, “[]” flashes or the unit beeps intermittently.	<ul style="list-style-type: none"> •Charge the battery fully (p. 14).
You charged the battery fully, but “Recharge” is still displayed and/or “[]” continues to flash.	<ul style="list-style-type: none"> •Clean the charge contacts and charge again (p. 15). •Install a new battery (p. 73).
The IN USE/CHARGE/HOLD indicator light does not go out after the battery has been charged.	<ul style="list-style-type: none"> •This is normal.
If you cannot solve your problem	<ul style="list-style-type: none"> •Call our customer call center at 1-800-211-PANA(7262). •Panasonic’s e-mail address for customer inquiries: consumerproducts@panasonic.com for customers in the USA or Puerto Rico ONLY
After Caller IQ is turned to off, the unit is unable to turn it back on and LCD shows “Listen & follow phone guidance.” without any voice prompt announced from the handset.	<ul style="list-style-type: none"> •Place the handset on the base unit, lift the handset and try again. •Check the settings (p. 81–83). •If you cannot solve a problem, consult openLCR (see below).
For more information about Caller IQ	<ul style="list-style-type: none"> •Call openLCR’s customer service department at 1-866-openLCR (1-866-673-6527). •openLCR’s web site: www.openLCR.com

openLCR Service for Caller IQ Feature

The Caller IQ feature is compatible with service provided by openLCR.

Important:

- **If you have any questions regarding the openLCR service, call openLCR's customer service department at 1-866-openLCR (1-866-673-6527).**
- NEITHER KYUSHU MATSUSHITA ELECTRIC CO., LTD. (KME) NOR MATSUSHITA ELECTRIC CORPORATION OF AMERICA (MECA) IS IN ANY WAY AFFILIATED WITH, OR RESPONSIBLE FOR THE ACTS OR OMISSIONS OF, OPENLCR.COM, INC. (OPENLCR). NEITHER KME NOR MECA NOR ANY OF THEIR EMPLOYEES OR AFFILIATES OR CUSTOMERS MAKE ANY WARRANTIES OR REPRESENTATIONS, EITHER EXPRESS OR IMPLIED, TO ANY CUSTOMER OR ANY OTHER THIRD PARTY WITH RESPECT TO ANY OF THE SERVICES PROVIDED BY OPENLCR, NOR ASSUME NOR CREATE ANY OTHER OBLIGATION OF ANY KIND ON BEHALF OF OPENLCR.



Setting Caller IQ to OFF and ON

After the first download to your phone, the Caller IQ features are automatically turned on. If you need, you can turn off Caller IQ.

To set Caller IQ to OFF (When Caller IQ is ON.)

1 Press **CALLER IQ**.

Press "1" or "#".
1:View Info.
#:Get new Info.

2 Press **0**.

To disable
Caller IQ,
press 3,#.

3 Press **3**.

To disable
Caller IQ,
press #.

4 Press **#**.

- A beep sounds and Caller IQ function is set to OFF.
- The handset will exit the programming mode.
- If 3 beeps sound, Caller IQ is not set to OFF. Start again from step 1.

Caller IQ off

To set Caller IQ from OFF to ON

1 Press **CALLER IQ**.

To enable
Caller IQ,
press 0,1,*.

2 Press **0**.

To enable
Caller IQ,
press 1,*.

3 Press **1**.

To enable
Caller IQ,
press *.

4 Press *****.

- A beep sounds and Caller IQ function is set to ON.
- The handset will exit the programming mode.
- If 3 beeps sound, Caller IQ is not set to ON. Start again from step 1.

Caller IQ on

•In steps 1 through 3, if you do not press any buttons for 60 seconds or you press **OFF**, the handset will exit the programming mode.

➡ openLCR Service for Caller IQ Feature

Downloading the Telephone Directory Data

To edit your telephone directory, go to the openLCR web site to update your directory, and then download the data to your unit. Accessing the openLCR web site can be done from any computer with Internet access, such as your home, work, library, Internet cafe, etc.

To edit the directory data

If you have already stored items into the directory of the unit, you need to enter all of that items on to the web. Then, add new items on the web site.

1. Go to openLCR's web site at **www.openLCR.com** and click on "Manage Account" tab.
2. Follow the web screen to edit the telephone directory data.
 - Make sure to enter a name up to 15 characters, and a phone number up to 22 digits.
 - In the case that you stored or edited the items in the directory of the unit, you also need to store or edit the items on the web site.
 - The description on the openLCR web screen is subject to change without notice.

To download the directory data from openLCR

- 1 Press  or , and then, press **CALLER IQ**.

To get
new Info.,
please press #.

- 2 Press **#**.
 - The unit will dial to openLCR automatically.
 - A voice prompt will be heard.

Talk
Listen & follow
phone guidance.

If you live in or move from another area to Fort Collins, Colorado, press **2** instead of **#**.

- 3 Follow the voice prompt to start downloading.
 - When the downloading starts, the display will show the message on the right.
 - After downloading starts, the handset must be off-hook. **DO NOT PLACE** the handset on the base unit (placing the handset on the base unit will terminate the download process). **DO NOT PRESS OFF** (pressing **OFF** will terminate the download process).

Download in
process.
Please wait.

- 4 When downloading is complete, a beep sounds.

Download OK!

•If 3 beeps sound and "Download incomplete. Directory full." is displayed, some items cannot be stored in the directory. Erase items which do not exist on the web from the directory of the unit (p. 50). Then, start again from step 1.

- You cannot access the openLCR server if a telephone or fax machine on the same phone line is in use.
- While the unit is downloading the data from openLCR, the Call Waiting Service cannot be used.

Information Download

This enables you to view information such as weather, lottery results and stock quotes from the LCD display on your openLCR-ready unit. Each time you download the data from openLCR, the information will be updated. To view up-to-date information, you will need to download to your unit.

- You can select the items of information on the web site which you want to view.

To update information

1 Press or , and then, press **CALLER IQ**.

2 Press **#**.
 • The unit will dial to openLCR automatically and start downloading information.

If you live in or move from another area to Fort Collins, Colorado, press **2** instead of **#**.

3 When downloading is complete, a beep sounds.

To view information

1 Press **CALLER IQ**.

Press "1" or "#".
 1:View Info.
 #:Get new Info.

2 Press **1**
 • The items of information which you selected on the web are displayed.

1:Weather
 2:Lottery
 3:Stock

3 Select the desired information by pressing dialing buttons **1** to **3**.

Ex. Weather

6-28 12:58pm
 Fort Collins CO
 78 F PartlyCldy

4 Find more information by pressing or .

H 90 L 70 F
 UV 2 Dew 64 F
 Humidity 42%

5 When finished, press **OFF** or place the handset on the base unit.

[Caller IQ on]

{■■■■}

Important Safety Instructions

When using this unit, basic safety precautions should always be followed to reduce the risk of fire, electric shock, or personal injury.

1. Read and understand all instructions.
2. Follow all warnings and instructions marked on this unit.
3. Unplug this unit from AC outlets before cleaning. Do not use liquid or aerosol cleaners. Use a damp cloth for cleaning.
4. Do not use this unit near water, for example, near a bathtub, washbowl, kitchen sink, or the like.
5. Place this unit securely on a stable surface. Serious damage and/or injury may result if the unit falls.
6. Do not cover slots and openings on the unit. They are provided for ventilation and protection against overheating. Never place the unit near radiators, or in a place where proper ventilation is not provided.
7. Use only the power source marked on the unit. If you are not sure of the type of power supplied to your home, consult your dealer or local power company.
8. Do not place objects on the power cord. Install the unit where no one can step or trip on the cord.
9. Do not overload wall outlets and extension cords. This can result in the risk of fire or electric shock.
10. Never push any objects through slots in this unit. This may result in the risk of fire or electric shock. Never spill any liquid on the unit.
11. To reduce the risk of electric shock, do not disassemble this unit. Take the unit to an authorized servicer when service is required. Opening or removing covers may expose you to dangerous voltages or other risks. Incorrect reassembly can cause electric shock when the unit is subsequently used.
12. Unplug this unit from the wall outlet and refer servicing to an authorized servicer when the following conditions occur:
 - A. When the power supply cord or plug is damaged or frayed.
 - B. If liquid has been spilled into the unit.
 - C. If the unit has been exposed to rain or water.
 - D. If the unit does not work normally by following the operating instructions. Adjust only controls covered by the operating instructions. Improper adjustment may require extensive work by an authorized servicer.
 - E. If the unit has been dropped or physically damaged.
 - F. If the unit exhibits a distinct change in performance.
13. During thunderstorms, avoid using telephones except cordless types. There may be a remote risk of an electric shock from lightning.
14. Do not use this unit to report a gas leak, when in the vicinity of the leak.

SAVE THESE INSTRUCTIONS

CAUTION:

To reduce the risk of fire or injury to persons, read and follow these instructions.

1. Use only the battery(ies) specified.
2. Do not dispose of the battery(ies) in a fire. They may explode. Check with local waste management codes for special disposal instructions.
3. Do not open or mutilate the battery(ies). Released electrolyte is corrosive and may cause burns or injury to the eyes or skin. The electrolyte may be toxic if swallowed.
4. Exercise care in handling batteries in order not to short the battery to conductive materials such as rings, bracelets, and keys. The battery and/or conductor may overheat and cause burns.
5. Charge the battery(ies) provided with or identified for use with this product only in accordance with the instructions and limitations specified in this manual.

WARNING:

TO PREVENT FIRE OR SHOCK HAZARD, DO NOT EXPOSE THIS PRODUCT TO RAIN OR ANY TYPE OF MOISTURE.

- The AC adaptor is used as the main disconnect device, ensure that the AC outlet is located/installed near the unit and is easily accessible.

FCC and Other Information

If requested by the telephone company, inform them as follows:

Registration No.(found on the bottom of the unit)

Ringer Equivalence0.1B

The particular telephone line to which the equipment is connected.

This unit must not be connected to a coin operated line.

If you are on a party line, check with your local telephone company.

Ringer Equivalence No. (REN):

The REN is useful in determining the quantity of devices you may connect to your telephone line and still have all of those devices ring when your telephone number is called. In most, but not all areas, the sum of the REN's of all devices connected to one line should not exceed five (5.0). To be certain of the number of devices you may connect to your line, as determined by the REN, you should contact your local telephone company to determine the maximum REN for your calling area.

In the event terminal equipment causes harm to the telephone network, the telephone company should notify the customer, if possible, that service may be stopped.

However, where prior notice is impractical, the company may temporarily cease service providing that they:

- (a) Promptly notify the customer.
- (b) Give the customer an opportunity to correct the problem with their equipment.
- (c) Inform the customer of the right to bring a complaint to the Federal Communication Commission pursuant to procedures set out in FCC Rules and Regulations Subpart E of Part 68.

The Telephone Company may make changes in its communications facilities, equipment, operations or procedures, where such action is reasonably required in the operation of its business and is not inconsistent with the rules and regulations in 47 CFR Part 68.

If such changes can be reasonably expected to render any customer terminal equipment incompatible with telephone company communications facilities, or require modification or alteration of such terminal equipment, or otherwise materially affect its use or performance, the customer shall be given adequate notice in writing, to allow the customer an opportunity to maintain uninterrupted service.

When programming emergency numbers and/or making test calls to emergency numbers:

1. Remain on the line and briefly explain to the dispatcher the reason for the call before hanging up.
2. Perform such activities in the off-peak hours, such as early morning hours or late evenings.

This device complies with Part 15 of the FCC Rules. Operation is subject to the following two conditions: (1) This device may not cause harmful interference, and (2) this device must accept any interference received, including interference that may cause undesired operation.

Privacy of communications may not be ensured when using this phone.

**CAUTION:**

Any changes or modifications not expressly approved by the party responsible for compliance could void the user's authority to operate this device.

Note:

This equipment has been tested and found to comply with the limits for a Class B digital device, pursuant to Part 15 of the FCC Rules. These limits are designed to provide reasonable protection against harmful interference in a residential installation. This equipment generates, uses, and can radiate radio frequency energy and, if not installed and used in accordance with the instructions, may cause harmful interference to radio communications. However, there is no guarantee that interference will not occur in a particular installation. If this equipment does cause harmful interference to radio or television reception, which can be determined by turning the equipment off and on, the user is encouraged to try to correct the interference by one or more of the following measures:

- Reorient or relocate the receiving antenna.
- Increase the separation between the equipment and receiver.
- Connect the equipment into an outlet on a circuit different from that to which the receiver is connected.
- Consult the dealer or an experienced radio/TV technician for help.

Some cordless telephones operate at frequencies that may cause interference to nearby TVs and VCRs. To minimize or prevent such interference, the base of the cordless telephone should not be placed near or on top of a TV or VCR. If interference is experienced, move the cordless telephone further away from the TV or VCR. This will often reduce, or eliminate, interference.

Operating near 2.4GHz electrical appliances may cause interference. Move away from the electrical appliances and/or press the CH (Channel) button.

CAUTION:

To comply with FCC RF exposure requirements, the base unit should be installed with its antenna located at 20 cm or more from persons and handset should be carried with the specific belt-clip provided for the handset to ensure compliance. Other non-tested belt-clips or similar body-worn accessories may not comply, therefore, should be avoided.

This equipment is hearing aid compatible.

A TIA/EIA-IS-968 compliant telephone cord and modular plug is provided with this equipment. This equipment is designed to be connected to the telephone network or premises wiring using a compatible modular jack that is also TIA/EIA-IS-968 compliant.

The software contained in this equipment to allow user access to the network must be ungraded to recognize newly established network area codes and exchange codes as they are placed into service.

Failure to upgrade the premises systems or peripheral equipment to recognize the new codes as they are established will restrict the customer and the customer's employees from gaining access to the network and to these codes.

➡ FCC and Other Information

- **Environment** — do not place the unit in a room where the temperature is less than 5°C (41°F) or greater than 40°C (104°F). Allow 10 cm (4") clearance around the unit for proper ventilation. Avoid excessive smoke, dust, mechanical vibration, shock, or direct sunlight.
- **Medical** — consult the manufacturer of any personal medical devices, such as pacemakers, to determine if they are adequately shielded from external RF (radio frequency) energy. (The unit operates in the frequency range of 2402MHz to 2480MHz, and the power output level can range 0.015 watts.) Do not use the unit in health care facilities if any regulations posted in the area instruct you not to do so. Hospitals or health care facilities may be using equipment that could be sensitive to external RF (radio frequency) energy.
- **Routine care** — wipe the unit with a soft cloth. Do not use benzine, thinner, or any abrasive powder. When you leave the unit unused for a long period of time, unplug the AC adaptor from the outlet.
- **If there is any trouble** — disconnect the unit from the telephone line and connect a known working phone. If the known working phone operates properly, have your unit repaired by one of the authorized Panasonic Factory Service Centers. If the known working phone does not operate properly, consult your telephone company.

Index

A Accessories	2	Intercom call	51
Answering calls	34	Intercom paging	51
Auto talk	19, 34	L LCD contrast	22
Automatic Security Code Setting ..	53	Lighted Handset Keypad	33
B Backlit LCD	33	Line mode	17
Base location	3	Listening to	
Battery, Charge	3, 14	messages	57, 65, 66, 69
Battery information	15	Location of controls	6, 7, 8
Battery replacement	73	M Making Calls	
Battery strength	15	Handset	30, 31
Belt Clip	72	Memo Message	61
C Caller IQ Information	83	Microphone	
Caller IQ Service	80	Base Unit	23, 34, 51
Call on hold	32	Handset	30, 34
Caller's recording time	28	Message storage time	24
Call waiting caller ID	54	Muting a conversation	53
Call waiting tone	54	N Noise	3
Caller ID Auto edit feature	39, 40	Number of rings	29
Caller ID service	27, 35, 54	O openLCR	80
Caller List		P PAUSE	54
editing	39	Pulse service	53
erasing	42	R Recording a conversation	61
storing	41	Recording time	23
viewing	36, 37	Redial	31
Calling back from Caller ID List ..	38	Redial list	32
Command menu	66, 67, 69	Remote code	63
D Day and time	26, 27	Remote operation	62, 68
Dialing mode	16	Ringer Off	20
Directory	43	Ringer Pattern	21
dialing	48	Ringer Volume	20
downloading	82	Rotary service, tone dialing	53
editing	49	S Safety Instructions	84
erasing	50	Slow Talk Message Playback	57
finding	47	Shipping product for service	90
name and symbols	45	SP-phone	
storing	44	Handset	31
Displays	9, 12	T Toll saver	29
E Erasing a message	60, 67, 69	Troubleshooting	
Erasing all messages	60, 67, 69	Answering System	77
F FCC and other information	86	Cordless telephone	75
FLASH button	55	General	78
Flash time	55	V Voice menu	64, 68
Function Menu	18, 25	Volume control	
G Greeting message	23	Base Unit	23, 52, 57
Greeting, answer setting	56	Handset	33
H Headset, optional	72		
Hold alarm	32		
I Installation			
AC adaptor	13		
Adding another phone	74		
Battery	14		
Telephone line cord	13		

For product service

- Call 1-800-211-PANA(7262) for the location of an authorized servicer.
- Panasonic's e-mail address for customer inquiries:
consumerproducts@panasonic.com
for customers in the USA or Puerto Rico ONLY

When you ship the product

- Carefully pack your unit, preferably in the original carton.
- Attach a letter, detailing the symptom, to the outside of the carton.

Symptom

- Send the unit to an authorized servicer, prepaid and adequately insured.
- Do not send your unit to the Panasonic Consumer Electronics Company listed on the back cover or to executive or regional sales offices. These locations do not repair consumer products.

- This cordless telephone is designed for use in the United States of America. Sale or use of this product in other countries may violate local laws.
- Ce téléphone sans fil est conçu pour être utilisé aux États-Unis d'Amérique. La vente ou l'emploi de cet appareil dans certains autres pays peut constituer une infraction à la législation locale.
- Este teléfono sin cordón fue elaborado para uso en los Estados Unidos de América. La venta o el empleo de este producto en ciertos países puede constituir violación de la legislación local.
- このコードレス電話機は、日本国外での使用を目的として設計されており、日本国内での使用は法律違反となります。従って、当社では日本国内においては原則として修理などのサービスは致しかねます。

**If you need assistance with the set-up or operation,
please call 1-800-211-PANA(7262)**

**Panasonic Consumer Electronics Company,
Division of Matsushita Electric Corporation of America**
One Panasonic Way, Secaucus, New Jersey 07094

**Panasonic Sales Company,
Division of Matsushita Electric of Puerto Rico, Inc.**
Ave. 65 de Infantería, Km. 9.5, San Gabriel Industrial Park
Carolina, Puerto Rico 00985